



INSTALLATION SETUP MANUAL

NETWORK AUDIO ADAPTER

NX-100

Please follow the instructions in this manual to obtain the optimum results from this unit.
We also recommend that you keep this manual handy for future reference.

TOA Corporation

TABLE OF CONTENTS

Chapter 1: BEFORE INSTALLATIONS AND SETTINGS

1. GENERAL DESCRIPTION	1-2
2. FEATURES	1-2
3. NOMENCLATURE AND FUNCTIONS	
[Front]	1-3
[Rear]	1-4
4. SETTING TASK FLOWS	1-5

Chapter 2: UNIT AND SOFTWARE INSTALLATIONS

1. CONNECTIONS	
1.1. Power Source Connections	
1.1.1. When using a 24V DC power source	2-2
1.1.2. When using the AC adapter	2-2
1.1.3. When simultaneously using the 24V DC power supply and the AC adapter	2-2
1.2. Terminal Connections	2-3
2. CONNECTIONS TO TERMINAL PLUGS	2-5
3. RACK MOUNTING	2-6
4. MAC ADDRESSES AND INSTALLATION LOCATIONS	2-7
5. SOFTWARE INSTALLATION	
5.1. System Conditions	2-8
5.2. Activating the Setup Launcher	2-8
5.3. Installing Java Runtime Environment	2-9
5.4. Installing the NX-100 Software	
5.4.1. Installation Procedures	2-11
5.4.2. Update information	2-14
5.4.3. Installation Folder Configuration	2-15
5.5. Uninstalling Each Software	2-15

Chapter 3: SYSTEM SETTINGS (NX-100 SETUP PROGRAM)

1. GENERAL DESCRIPTION	
1.1. What is the NX-100 Setup Program?	3-2
1.2. About Network Settings	3-2
1.3. Backing-Up Setting Files	3-2
1.4. Cautions Concerning Setting Updates	3-2

2. SETUP SOFTWARE CONFIGURATION AND SETTING ITEMS	
2.1. Setup Program Types	
2.1.1. Installation Setting Program	3-3
2.1.2. Management Setting Program	3-3
2.2. Setting Items Table	3-3
3. SETTING PROCEDURE	3-4
4. STARTUP	
4.1. Starting the Installation Setting Program	3-6
4.2. Starting the Management Setting Program	3-8
5. UNIT SCANNING TOOL	
5.1. Screen Description	3-9
5.2. Menu	
5.2.1. File	3-10
5.2.2. Scan	3-10
5.2.3. Help	3-11
5.3. Buttons	3-11
5.4. Scanning Units	3-11
5.5. Changing the Unit Setting Values	3-12
5.6. Automatic IP Address Assignment	3-12
5.7. Subnet Mask and Default Gateway Settings	3-13
6. SYSTEM SETTING TOOL	
6.1. Screen Description	3-14
6.2. Menu	
6.2.1. File	3-15
6.2.2. Edit	3-15
6.2.3. Setting	3-15
6.2.4. Help	3-15
6.2.5. Buttons	3-16
6.3. Network Setting	3-17
6.4. Broadcast Spec Setting	3-19
6.5. Broadcast Pattern Setting	
6.5.1. Setting new broadcast patterns	3-21
6.5.2. Editing broadcast patterns	3-23
6.6. Contact Setting	
6.6.1. Contact input setting	3-24
6.6.2. Contact output setting	3-26
6.7. Serial Bridge Setting	3-28
6.8. System Settings	3-30
6.9. Saving the Unit Setting Files	3-30
6.10. Reopening Unit Setting Files	3-31
6.11. Downloading the Operation Logs	3-31
6.12. Uploading Unit Setting Files	3-31
6.13. Downloading Unit Setting Files	3-31
6.14. Updating Firmware	3-31
7. CHANGING THE SYSTEM NAME AND PASSWORD	3-32

Chapter 4: SYSTEM SETTINGS (SETTING USING BROWSER)

1. OUTLINE OF SETTING USING BROWSER	4-2
2. SETTINGS	4-2
3. NETWORK SETTING	4-4
4. BROADCAST SPEC SETTING	4-6
5. BROADCAST PATTERN SETTING	4-9
5.1. Pattern Selection Area	4-10
5.2. Pattern Edit Area	
5.2.1. Pattern addition	4-10
5.2.2. Pattern editing	4-12
6. CONTACT SETTING	4-13
6.1. Contact Input Setting	4-14
6.2. Contact Output Setting	4-16
7. SERIAL BRIDGE SETTING	4-18
8. LOG MANAGEMENT	4-20
8.1. Operation Log	4-21
8.2. Saving Operation Logs	4-23
8.3. Stream Logs	4-24
8.4. Operation Status	4-26
9. SYSTEM MANAGEMENT	4-27

Chapter 5: OPERATION SETTINGS (NX-100 OPERATION PROGRAM)

1. NX-100 OPERATION PROGRAM SUMMARY	5-2
2. STARTUP AND INITIAL SCREEN	5-2
3. OPERATION SCREEN DESCRIPTION	5-3
4. MENU	
4.1. File	5-4
4.2. Settings	5-4
4.3. Help	5-4
5. SETTING PROCEDURES USING THE OPERATION PROGRAM	5-5
6. UNIT SETTING ADDITION	5-6
7. SETTING THE SELECTION BUTTON CONTENTS	5-8
8. SETTING THE GROUP BUTTON CONTENTS	5-12
9. ERROR MESSAGES	5-14

1. EXPLANATION	
1.1. IP Network and Address	6-2
1.2. Network Address Translation (NAT) and Setup Software Programs	6-3
1.3. IP Broadcast and Unit Scan	6-3
1.4. Multicast and Simultaneous Multiple Broadcasts	6-4
1.5. Packet Loss Recovery	6-4
1.6. Contact OFF Delay Time	6-4
1.7. Sampling Frequency Correction	6-4
2. TROUBLESHOOTING	6-5
3. SPECIFICATIONS	6-7

Chapter 1

BEFORE INSTALLATIONS AND SETTINGS

1. GENERAL DESCRIPTION

TOA's NX-100 Network Audio Adapter is specially developed to transmit high-quality audio signals and such control data as serial data over IP networks such as LAN or Internet in real time.

[Audio Signal Flow Chart]

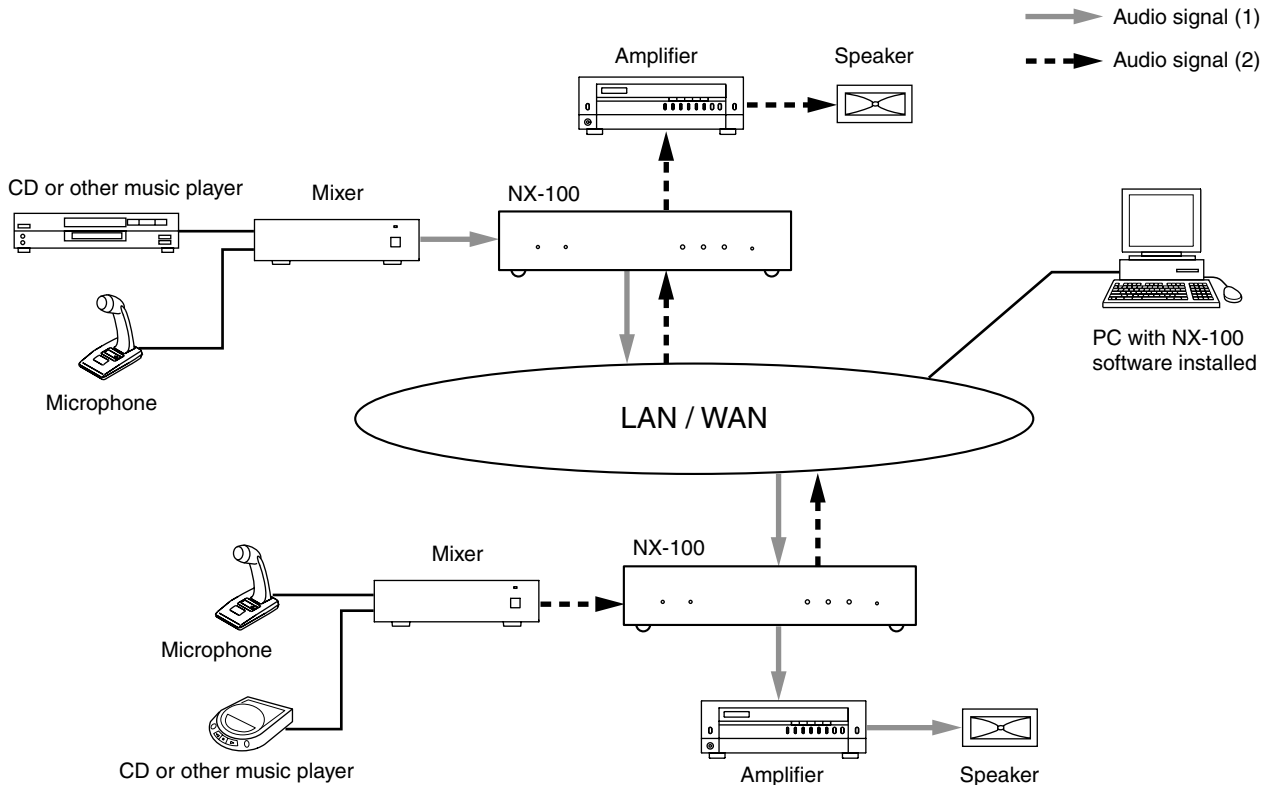

2. FEATURES

- Permits use of not only dedicated lines, but also the Internet, which greatly reduces operating costs when transmitting audio signals to remote locations.
- Under peak conditions with no network delay, audio signals can be transmitted with a minimal delay of about 20 ms.
- Transmission of control data, such as contact and serial data, possible.
- Simultaneous bi-directional transmission of audio signals possible.
- Simultaneous transmission of audio signals to multiple locations (up to 4 locations for unicast*¹ streaming, 64 locations for multicast*² streaming) possible.
- Enables loss-free audio signal transmission even over congested networks such as the Internet.
- The entire system can be remotely operated or managed from a single PC (personal computer) using the supplied software program.
- Because audio transmissions can be started and finished via the unit's contact inputs, systems can be configured even without the use of a personal computer.
- Designed to operate on both AC and DC power sources.

*¹ UNICAST: A communications method used to transmit audio data to designated addresses in a matched ratio of 1:1. Up to 4 channels can be simultaneously transmitted.

*² MULTICAST: A communications method used to simultaneously transmit a single audio data source to multiple destinations.

3. NOMENCLATURE AND FUNCTIONS

[Front]

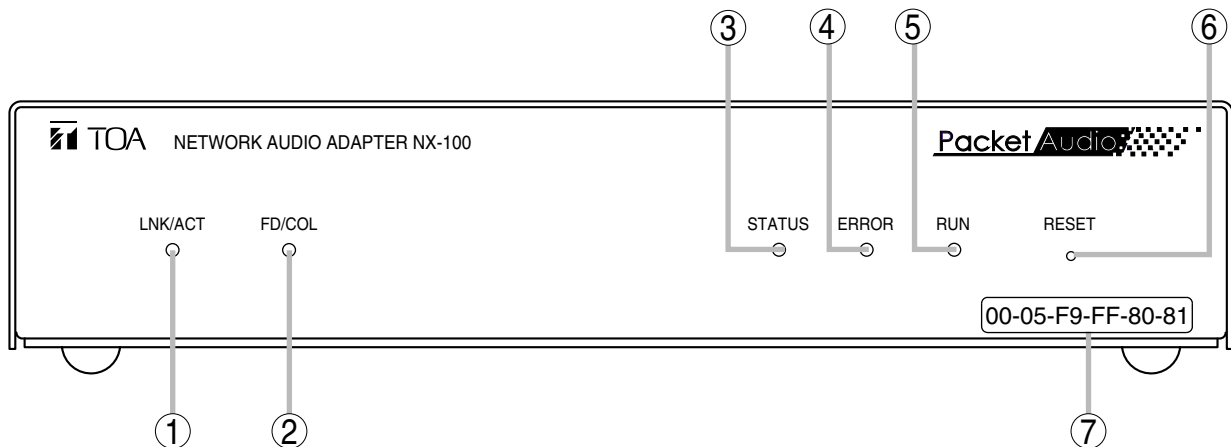

1. LNK/ACT Indicator (Green)

Lights when the unit is connected to a network.
Flashes while the unit is transmitting or receiving data.

2. FD/COL Indicator (Yellow)

Remains lit while the network is in full-duplex communications mode.
Flashes whenever data collision is detected.

3. Status Indicator (Yellow)

Remains lit during broadcasts.
Flashes while the unit is writing data into the internal storage medium (flash memory).

4. Error Indicator (Red)

Lights if an error is detected during transmission, etc.

5. Run Indicator (Green)

Remains lit during normal operation.
Flashes at 2-second intervals when a failure is detected.

6. Reset Button

Restarts the unit when pressed.

7. MAC Address

The unit's MAC address consists of 12 hyphenated alphanumeric characters.

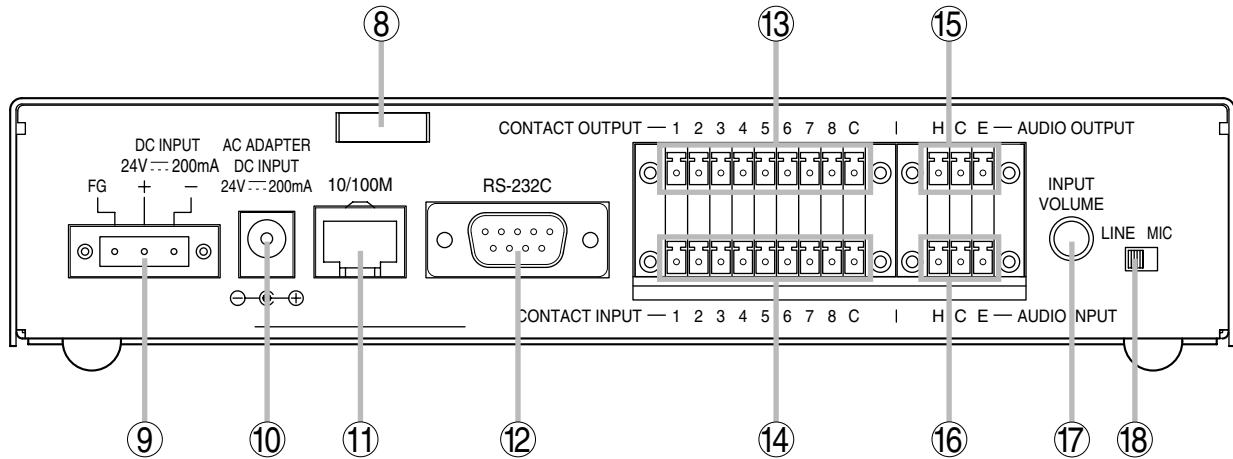
[Rear]**8. Cord Clamp**

Pinches and securely holds the AC adapter cord to prevent its plug from detaching.

9. DC Power Input Terminal [DC INPUT]

A 24 V DC input.

10. Power Input Terminal [AC ADAPTER]

Connect the AC adapter* to this terminal.

* Use the AD-246 (optional) or its equivalent.

11. Network Connection Terminal [10/100M]

Connects to 10/100 Base-T networks. (RJ-45 Ethernet jack)

12. RS-232C Terminal

A 9-pin D-sub connector (male).

13. Control Output Terminal [CONTACT OUTPUT]

An open collector output (Withstand voltage: 30 V DC, Control current: 50 mA maximum).

14. Control Input Terminal [CONTACT INPUT]

A no-voltage "make" contact input (Short circuit current: 10 mA, Open voltage: 12 V).

15. Audio Output Terminal [AUDIO OUTPUT]

A 0 dB/600 Ω balanced output. Line level audio signal output.

H: Hot

C: Cold

E: Ground (shield)

16. Audio Input Terminal [AUDIO INPUT]

A -58 to 0 dB/2 k Ω balanced input. Microphone or line level audio signals can be connected to this terminal.

H: Hot

C: Cold

E: Ground (shield)

17. Input Volume Control [INPUT VOLUME]

Adjusts the audio input level. Set this control to eliminate distortion in the input signal.

18. Input Level Selection Switch [LINE/MIC]

Set this switch to the MIC (right side) position when using a microphone, and to the LINE (left side) for other inputs. (Factory-preset to the LINE position.)

4. SETTING TASK FLOWS

(1) Unit Installation and Connection

Refer to [Chapter 2, Unit and Software Installation](#).

(2) Software Installation

Install the setup program, operation program, and Java Runtime Environment in the personal computer (PC).

- The setup program can perform settings for multiple NX-100 units connected to the same network.
- The operation program enables the PC to remotely operate the network PA system to make broadcasts.
- Both the setup and operation software programs are written in the Java programming language. To use them, install Java Runtime Environment.

Note

Refer to [p. 2-8, Software Installation](#), for the installation procedure.

(3) System Setting

There are two setting methods:

1. Setting Using NX-100 Setup Program

This method permits integrated settings and management of the entire system by automatically scanning the NX-100 units connected to the LAN.

Note

Refer to [Chapter 3, System Settings \(NX-100 Setup Program\)](#), for the setting procedure.

2. Setting Using Browser

Individual settings can be performed using Internet Explorer or a similar browser, which comes standard-installed in most PCs, without having to install the software program anew. Use the browser for setting any NX-100 units connected to the Internet using the NAT function.

Note

Refer to [Chapter 4, System Settings \(Setting Using Browser\)](#), for the setting procedure.

(4) Operation-Related Settings

The NX-100 Operation Program is required to make broadcasts from the PC. The Operation Program performs settings using the setting data prepared in (3) System Setting above.

Note

Refer to [Chapter 5, Operation Settings \(NX-100 Operation Program\)](#), for the setting procedure.

Chapter 2

UNIT AND SOFTWARE INSTALLATIONS

1. CONNECTIONS

1.1. Power Source Connections

1.1.1. When using a 24V DC power source

Connect a 24V DC power source to the unit's DC INPUT terminal.

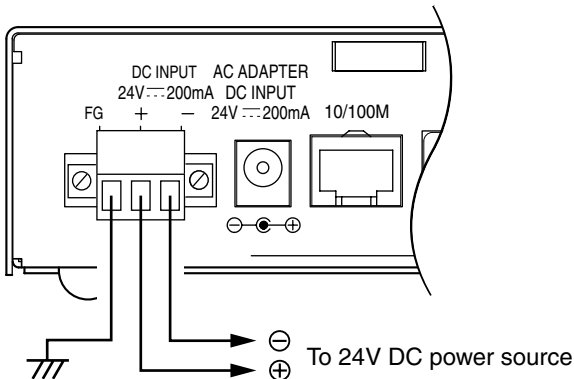

Notes

- Be sure to connect the unit's FG terminal to the ground terminal of the amplifier or mixer.
- The DC power supply must have a capacity of over 200 mA.
- The range of input voltage to be fed to the DC INPUT terminal should be between 21.6 V and 26.4 V DC. If the input voltage exceeds this range, the unit may malfunction or fail.
- Refer to [p. 2-5, CONNECTIONS TO TERMINAL PLUGS](#), for connector connection procedures.

1.1.2. When using the AC adapter

Connect the AC adapter* to the unit's AC ADAPTER terminal. Pinch the cord with a clamp and securely fix it.

* Use the AC adapter AD-246 (optional) or the equivalent. As for the usable adapter, consult your TOA dealer.

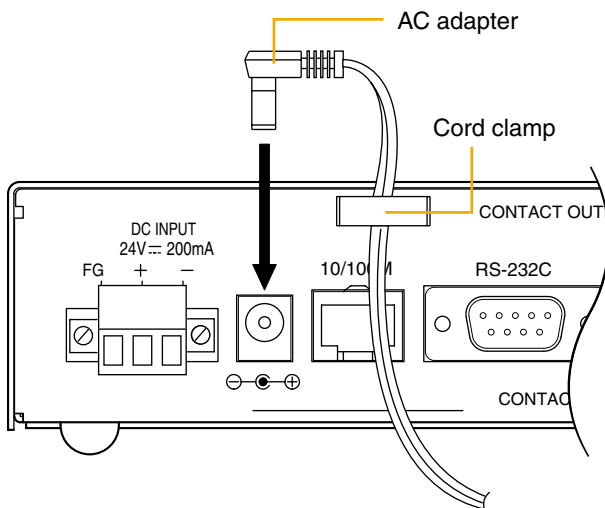

Note

When noise interference affects voice output, connecting the unit's FG terminal to the ground terminal of the connected amplifier or mixer may improve the condition.

1.1.3. When simultaneously using the 24V DC power supply and the AC adapter

When both the 24V DC power supply and the AC adapter are simultaneously used, the AC adapter takes precedence. However, should power from the AC adapter be interrupted due to a power failure, etc., the power supply will automatically switch over to the unit's 24V DC power source. Connecting a battery directly to the DC INPUT terminal also permits it to be used as backup power supply during a power failure.

1.2. Terminal Connections

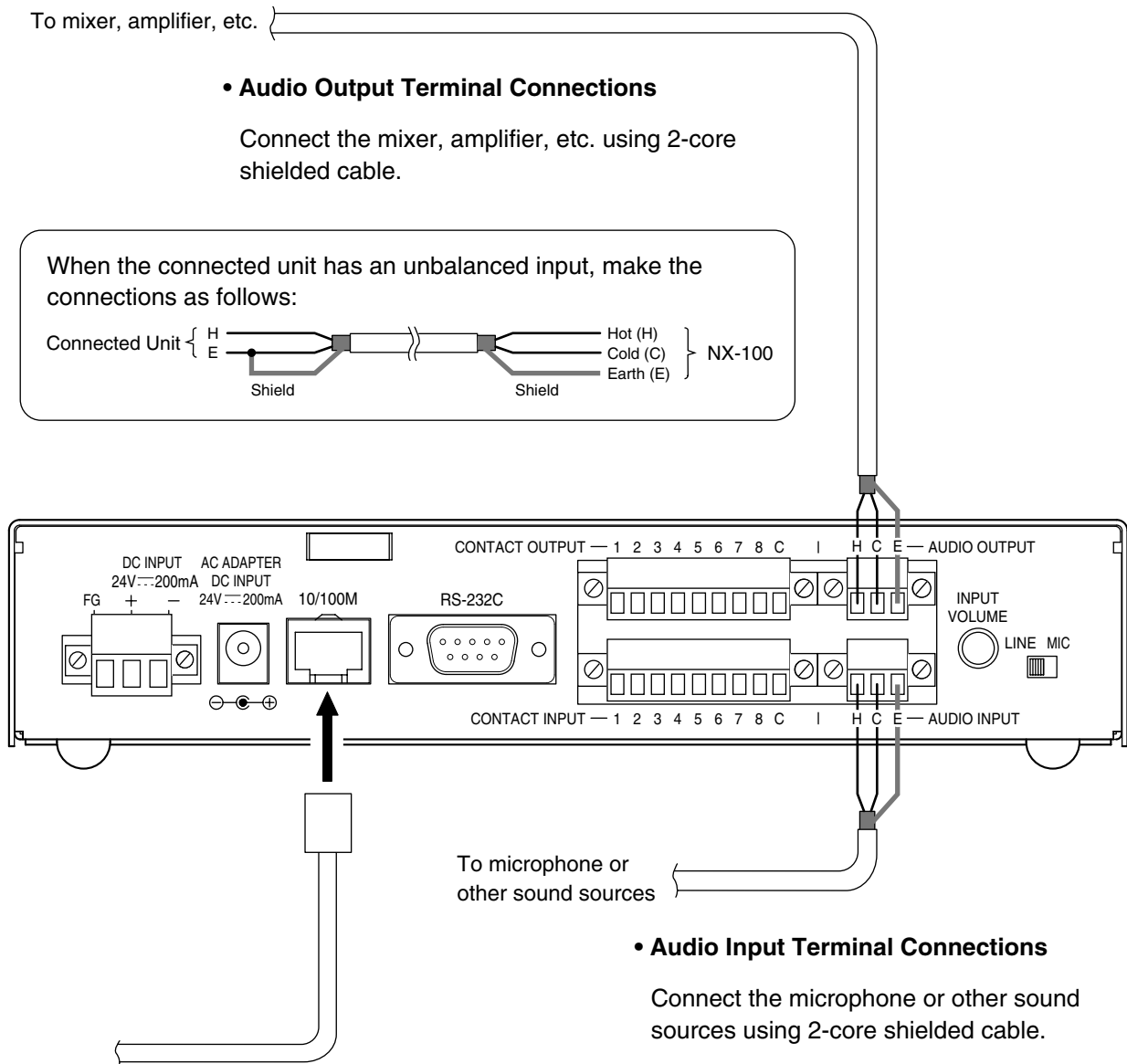

- **Network Connections**

The NX-100 automatically distinguishes between 10BASE-T and 100BASE-TX networks, and establishes a connection. For this connection, use a "straight" UTP Category 5 LAN (Ethernet) cable fitted with an RJ-45 connector.

Tip

Refer to [p. 2-5, CONNECTIONS TO TERMINAL PLUGS](#), for audio terminal connection procedures.

• Control Output Terminal Connections

Connect the control input terminals of all other connected units using 2 control lines.

[Control Output Specifications]

Open collector output
 Withstand voltage: 30 V DC
 Control current: 50 mA maximum
 Pulse width: 1 s (when in Latch mode)

Caution
 Be sure to connect only these control lines to other unit's control input terminals. Connecting in parallel with control lines from other equipment may cause the unit to malfunction.

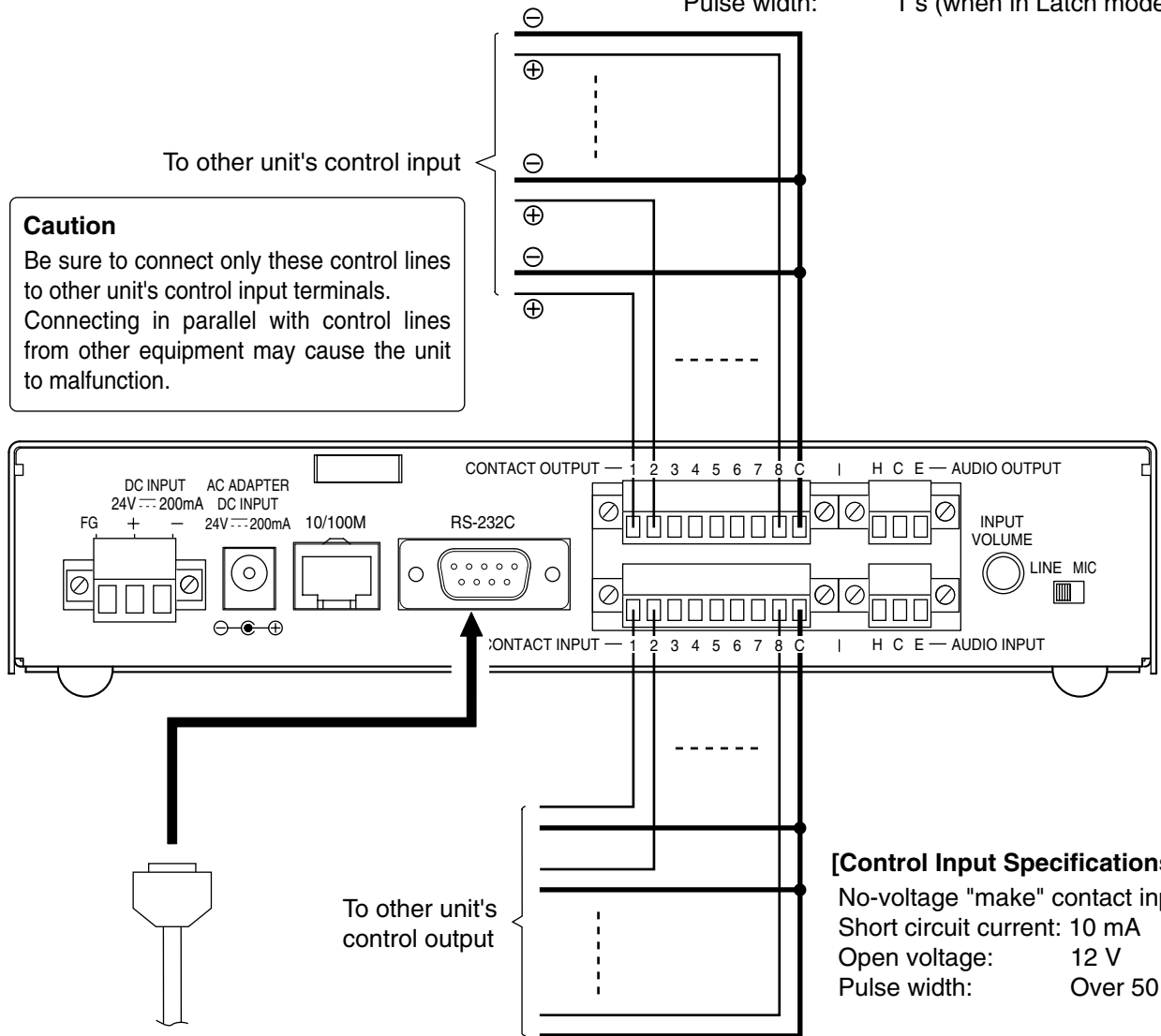

[Control Input Specifications]
 No-voltage "make" contact input
 Short circuit current: 10 mA
 Open voltage: 12 V
 Pulse width: Over 50 ms

• RS-232C Interface Connections

The NX-100 can be used to control such RS-232C components as DTE and DCE components over a network. Use a "straight" cable fitted with a 9-pin D-sub connector when connecting to DTE components such as PCs. Use a "cross" cable fitted with a 9-pin D-sub connector for connecting to DCE components such as modems.

• Connections to the Control Input Terminal

Connect the control output terminals of all other connected units using 2 control lines.

Tips

- Refer to [p. 2-5, CONNECTIONS TO TERMINAL PLUGS](#), for control terminal connection procedures.
- When not using the RS-232C interface, place the supplied RS-232C cover over the terminal to protect it against dust.

2. CONNECTIONS TO TERMINAL PLUGS

Wire the removable terminal plugs for power input, audio input and output, and control input and output as follows:

[Cable size and width to strip]

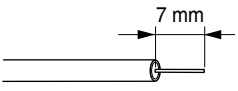
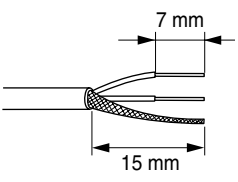
Application	Size	Width to Strip
For power supply terminal	AWG24 – 12	Solid cable and stranded cable 
For audio terminal For control terminal	AWG28 – 16	Shielded cable 

Caution

Avoid soldering stranded or shielded cable, as contact resistance may increase when the cable is tightened and the solder is crushed, possibly resulting in an excessive rise in joint temperatures.

[Wiring procedure]

Step 1. Wiring the supplied removable terminal plugs.

1-1. Loosen the terminal screws to insert the wire.

1-2. Tighten the terminal screws. Ensure that the wire does not break free when pulled. If the wire does pull free, repeat the connection procedure from the start.

Step 2. Insert the wired terminal plug into the corresponding terminal block in the unit's rear panel.

Step 3. Tighten the fixing screws.

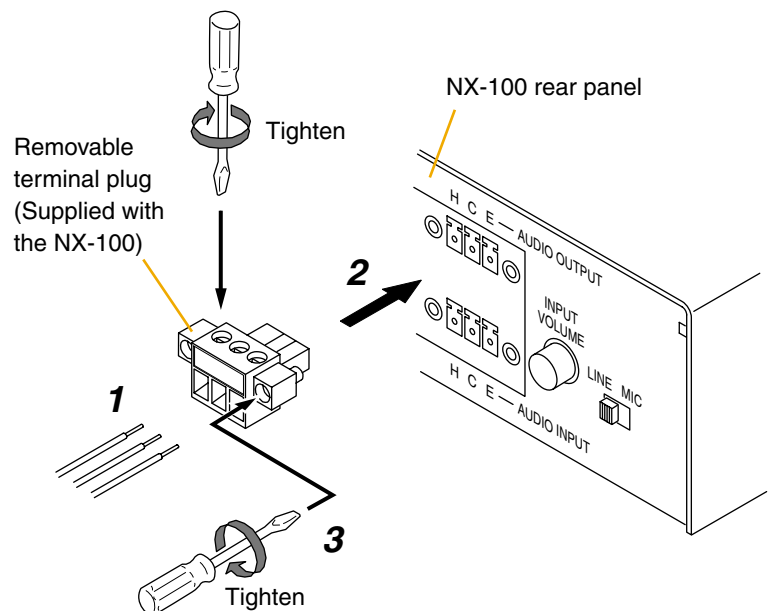

Cautions

- Do not reverse **Steps 1** and **2**. Poor contact may result if force is applied to the unit's internal circuit board pins while the terminal screws are being tightened.
- Use an appropriate type screwdriver for terminal plug wiring.

3. RACK MOUNTING

Use the optional mounting hardware set when installing the unit in an equipment rack. Be sure to remove the rubber feet located on the unit's bottom surface before mounting.

- Use the optional MB-15B-BK hardware set when mounting a single unit.

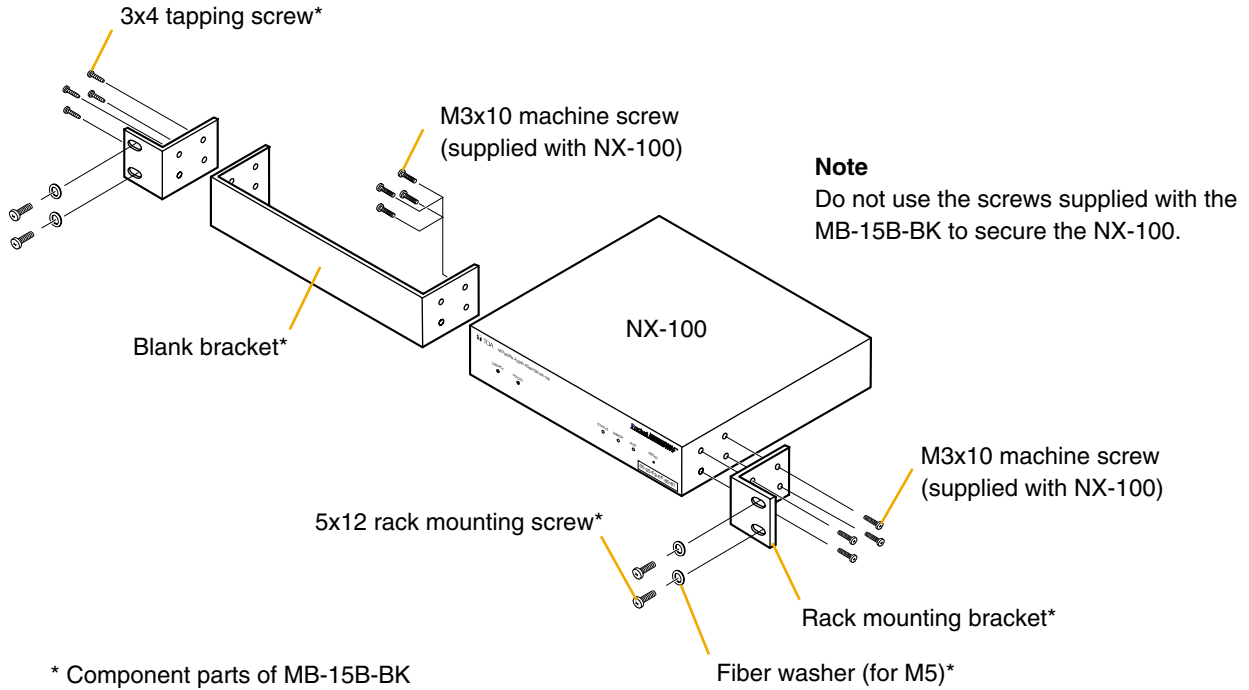

- Use the optional MB-15B-J hardware set when mounting 2 units.

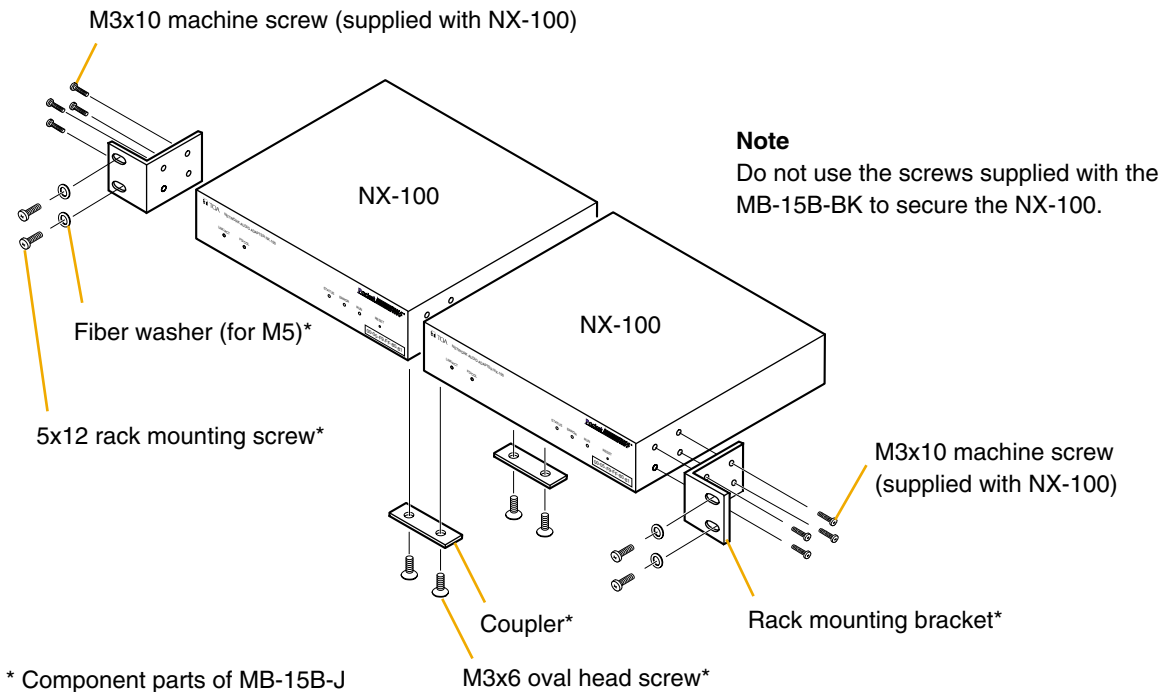

4. MAC ADDRESSES AND INSTALLATION LOCATIONS

When making the unit's network settings, the unit's MAC address* must have a clear association with its corresponding installation location. Be sure to record the relationship during installation to facilitate later network settings.

* A 12-digit hexadecimal address number peculiar to and assigned to the network-connected unit.

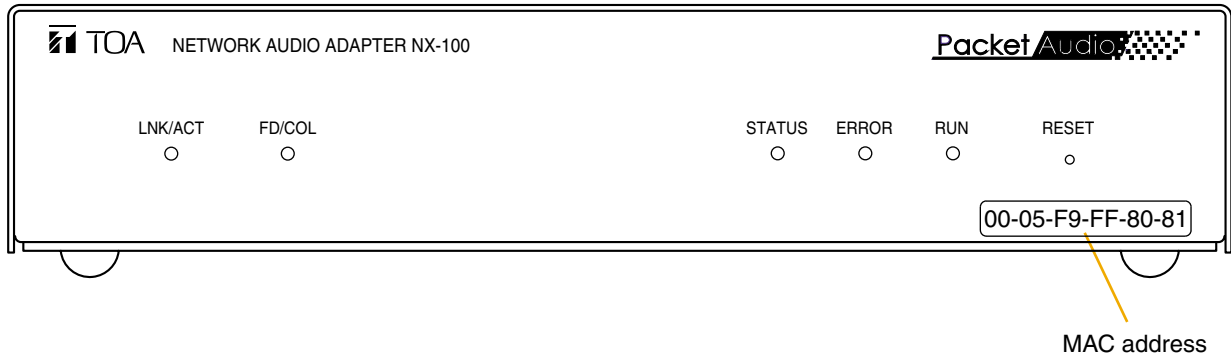

5. SOFTWARE INSTALLATION

5.1. System Conditions

The following minimum PC (personal computer) specifications are required in order to correctly operate the unit's software program.

- OS: Windows 2000/XP
- CPU: Pentium III 800 MHz or greater
- RAM: 256 MB or greater
- Disk Space: 40 MB or greater

Notes

- Windows is a trademark of Microsoft Corporation.
- Pentium is a trademark of Intel Corporation.

5.2. Activating the Setup Launcher

The Setup Launcher is automatically started when the supplied CD-ROM is inserted into the PC's drive.

Note

The Setup Launcher will not be automatically activated when the CD-ROM is inserted if the PC's CD drive is not compatible with an auto-run function. In such cases, execute the "Setup Launcher" file below using "Explorer" or "My Computer" or select Start → Run on the taskbar to enter the command below:

<Drive in which a CD is inserted> \Autorun.exe

[Example] When a CD is inserted into drive e → e:\Autorun.exe



5.3. Installing Java Runtime Environment

The following procedures do not need to be carried out if **Java 2 Runtime Environment, Standard Edition, v1.3.1** has already been installed in the PC.

Step 1. Quit other activated applications before installation.

Step 2. Click "Java 2 Runtime Environment, Standard Edition, v1.3.1" of the Setup Launcher. The installer will be activated.



Step 3. Click the Yes or Next button as instructed by the screen. Installation will begin and the progress status displayed.

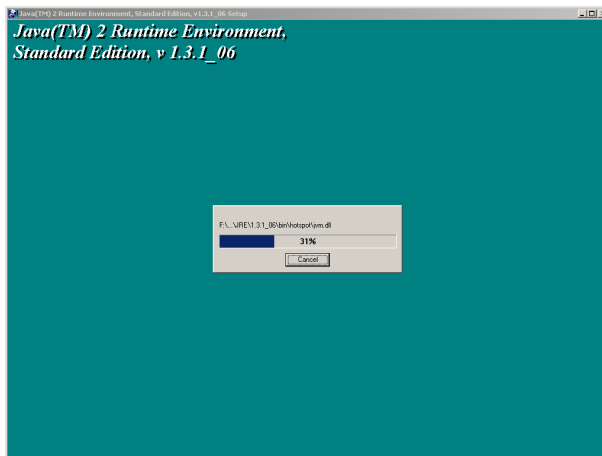

The "Installation completed OK." indication will be displayed upon installation completion.

Tip

Check the correct Runtime installation or version number from "Control Panel."

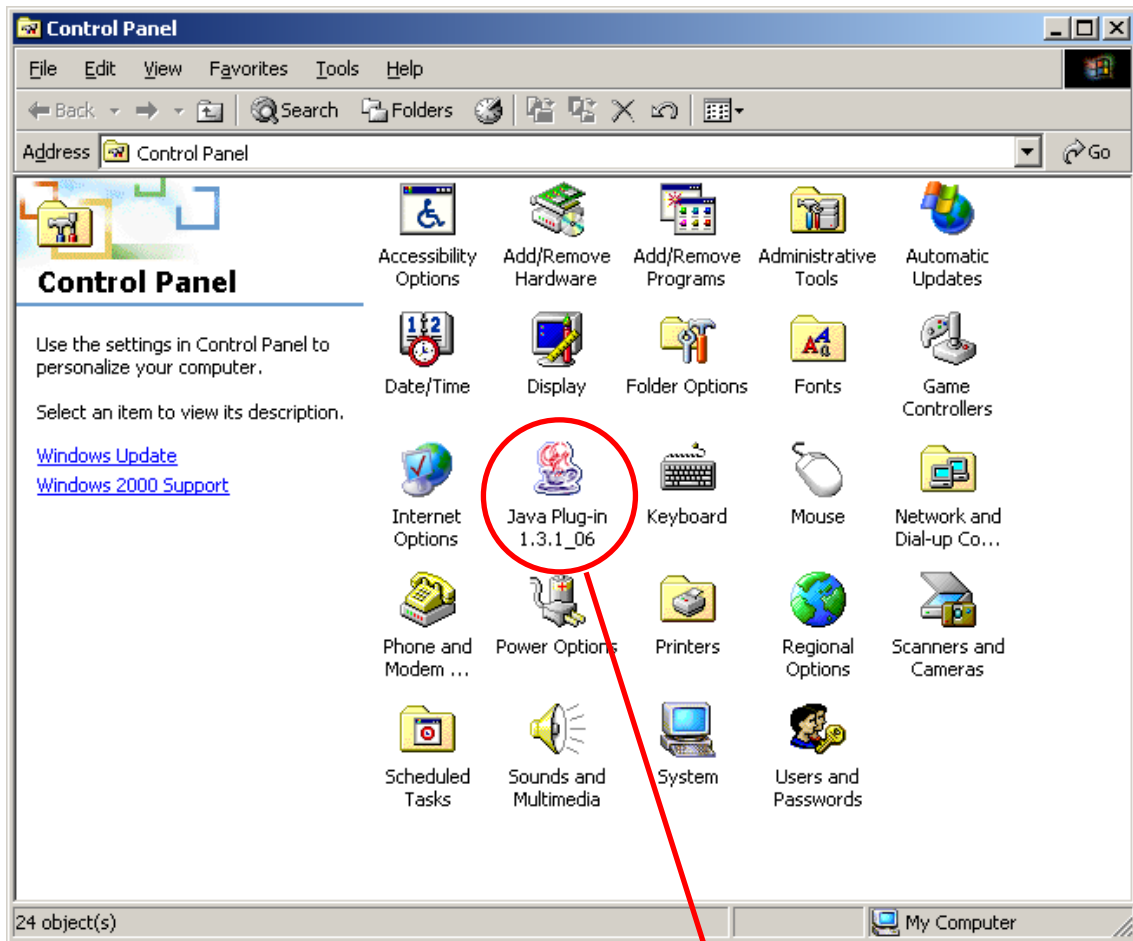

Installation completion icon

5.4. Installing the NX-100 Software

The NX-100 software consists of the following 3 programs.

- **NX-100 Setup Program (Installation Setting)**
Enables integrated setting of the NX-100 from the PC.
- **NX-100 Setup Program (Management Setting)**
Enables integrated setting of the NX-100 from the PC.
A portion of the items, such as a network setting, cannot be set.
- **NX-100 Operation Program**
Enables integrated setting of the NX-100 from the PC for broadcast activation.
Install this software program to operate the unit from the PC.

5.4.1. Installation Procedures

- Step 1.** Click "NX-100 Software" in the Setup Launcher.
The installer will be activated.

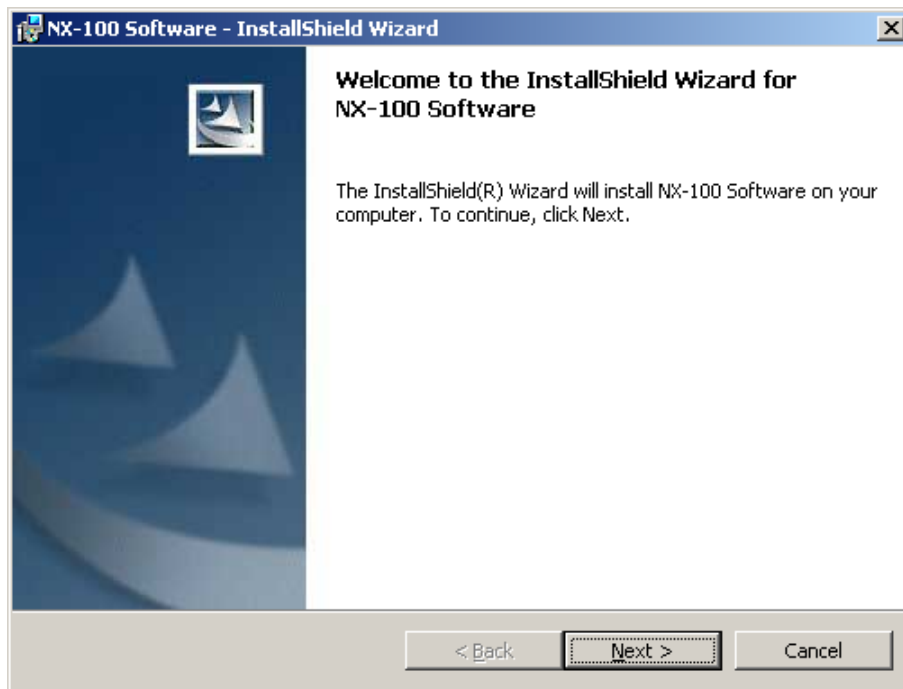

- Step 2.** Click the Next button.
The screen "Destination Folder" will be displayed.

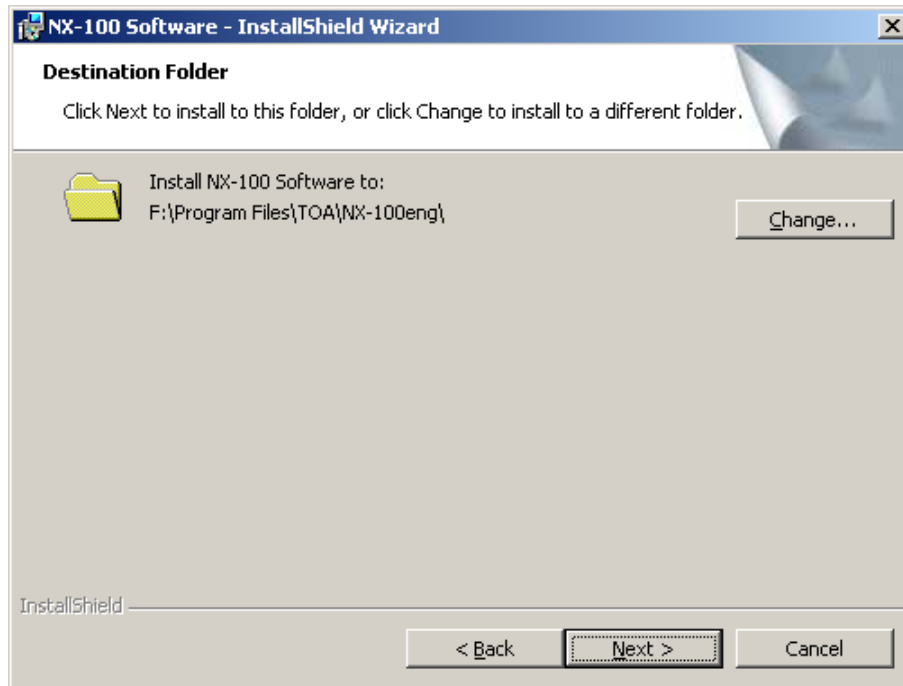

- Step 3.** When installing in a different folder from the one displayed, press the Change button to select the desired folder. Press the Next button if the currently displayed folder is correct.
The "Setup Type" screen will be displayed.

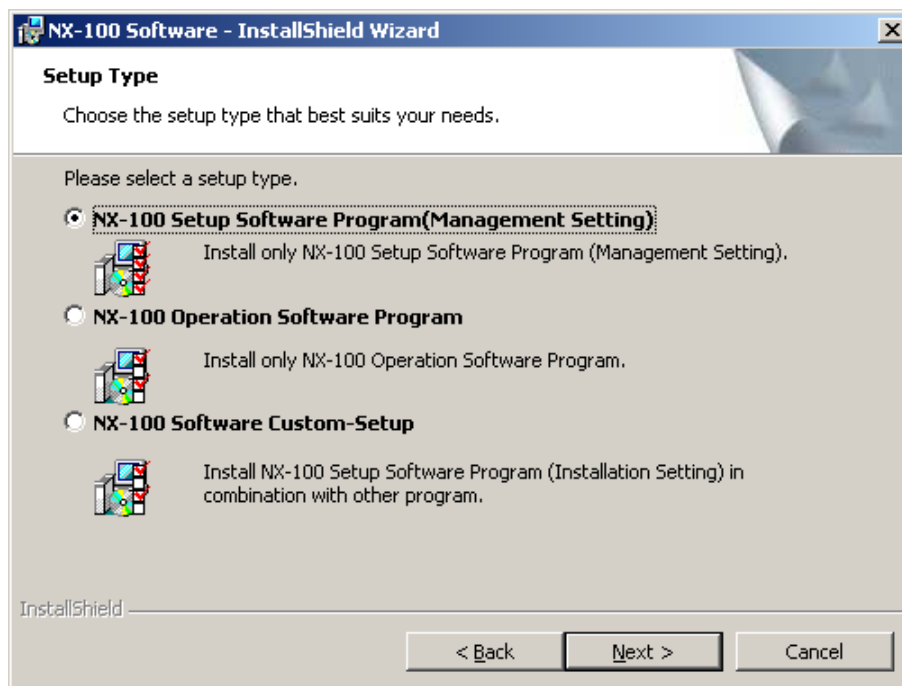

Step 4. Select the NX-100 software program to install, then press the Next button.

Tip

When installing the NX-100 Setup Program (Installation Setting) or simultaneously installing two or more programs (example: Setup Program and Operation Program), select "NX-100 Software Custom-Setup."

[If something other than NX-100 Software Custom-Setup is selected]

Installation will begin.

[If NX-100 Software Custom-Setup is selected]

The screen for selecting the software program to install in Custom Setup mode is displayed.

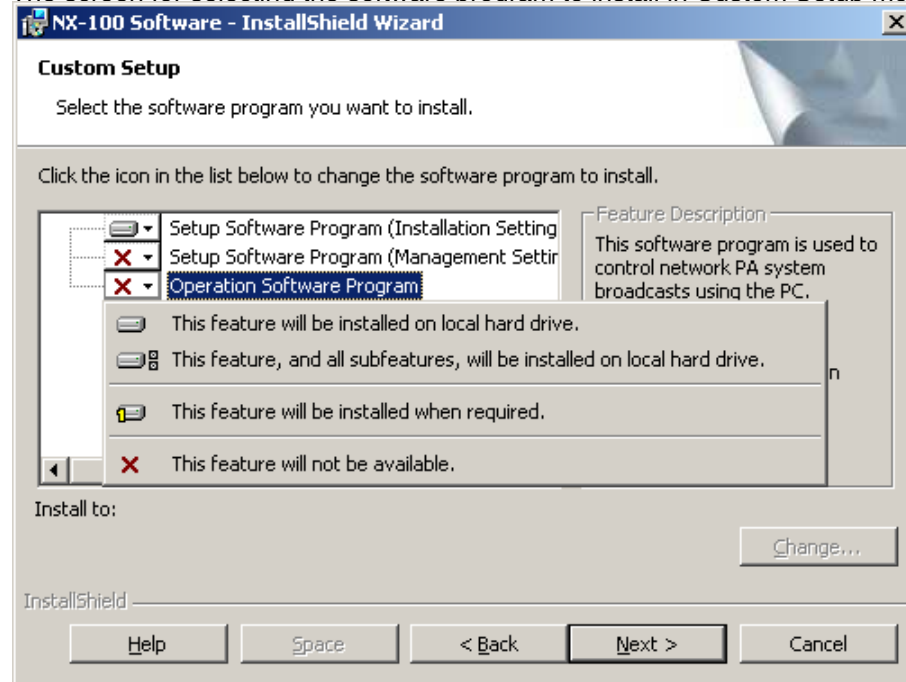

4-1. Click the icon to select software program.

The popup menu for selecting the installation method will be displayed.

4-2. Select "This feature will be installed on local hard drive." for the software program(s) to be installed, and "This feature will not be available." for software program(s) not to be installed.

4-3. Press the Next button.

Installation will begin.

Step 5. Press the Finish button when the indication "InstallShield Wizard Completed" is displayed after installation completion.

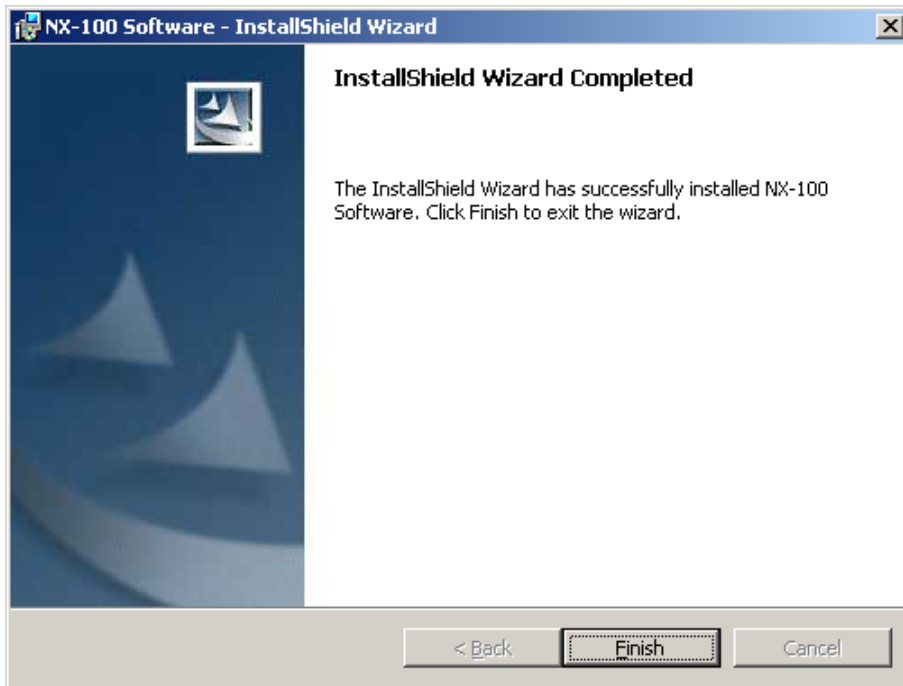

Tip

An icon for the installed NX-100 software program is created on the desktop.

NX-100 Setup Program (Installation Setting):



NX-100 Setup Program (Management Setting):



NX-100 Operation Program:



5.4.2. Update information

- The latest versions of the following software and manuals are open to the public on the Toa's download site <http://www.toa-products.com/international/>: NX-100 firmware, NX-100 software (Setup program and Operation program), and Instruction manuals (Installation setup manual and Operations manual). Please download them from the above web site.
- To confirm the NX-100 software version, use the Help menu of the software.
- The version of each instruction manual is in the lower right corner on the last page expressed in a year-month format. Example: "200304" represents 2003, April.

5.4.3. Installation Folder Configuration

The installed software program is stored by default in C:\Program Files\TOA\NX-100. The installation folder is configured as follows. (However, the unit setting file is only created after having been set by the setup program, and the unit operation log is created after the NX-100's first actual operation.)

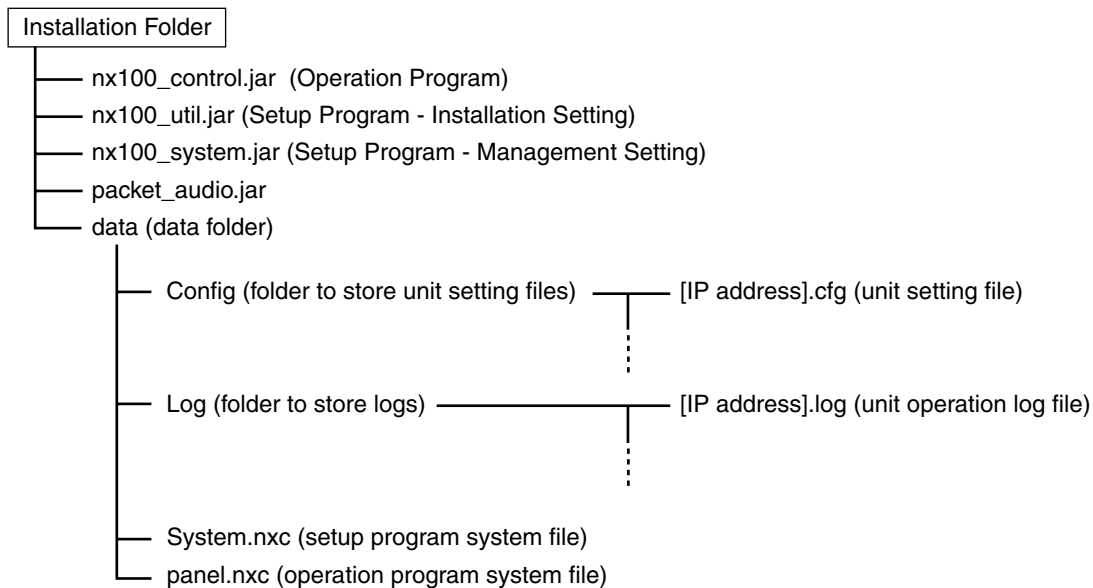

Data in the data folder are commonly used by both the Setup Program and the Operation Program. The Setup Program and the Operation Program always operate based on the unit setting files in the data folder.

Manually opening or saving these files cannot be performed.

Do not change the configuration or name of the file or folder in the installation folder.

When creating other systems or saving backup copies, copy the data folder into other location and save it. (To reuse, replace the data folder with the one in use.)

5.5. Uninstalling Each Software

Select [Control Panel] → [Add/Remove Programs] to delete.

Chapter 3

SYSTEM SETTINGS (NX-100 SETUP PROGRAM)

1. GENERAL DESCRIPTION

1.1. What is the NX-100 Setup Program?

This program is used to set all the NX-100 units connected to a LAN. It also provides a simple display on the PC screen of operating data for multiple NX-100 units connected to a LAN. Its main features are as follows:

- Scans and displays all NX-100 units connected to a LAN.
- Automatically sets IP addresses without duplication. Permits manual changes as well.
- Permits simultaneous uploading of setting files to two or more NX-100 units.
- Backs up setting files for two or more NX-100 units in a batch.
- Easily and efficiently performs broadcast settings between units.

Note

When setting the unit connected to the Internet, refer to [Chapter 4, System Settings \(Setting Using Browser\)](#).

1.2. About Network Settings

Follow the instructions of the network management personnel before performing network settings for the PC and connected units. Incorrect settings may adversely influence other units connected to the same network.

1.3. Backing-Up Setting Files

Setting contents, once saved, are saved in the data folder located inside the Setup program's installation folder (Default path: C:\Program Files\TOA\NX-100) as a unit setting file. If uploaded, these files are stored in each NX-100 as unit setting files. It is highly recommended that all settings be backed up. Backing up settings to other locations on the PC hard drive or to external storage devices facilitates restoration should the NX-100 or PC inadvertently fail. To save backup copies, copy the entire data folder located in the Setup program's installation folder.

Caution

When settings are changed, be sure to update the backup files as well.

1.4. Cautions Concerning Setting Updates

Never restart the NX-100 unit nor turn off its power supply while updating* the setting contents.

* The Status indicator on the unit's front panel flashes during an update.

2. SETUP SOFTWARE CONFIGURATION AND SETTING ITEMS

2.1. Setup Program Types

There are two setup programs, each of which enables different setting contents.

2.1.1. Installation Setting Program

Permits settings of all items including unit scanning and network setting. First set all items using this software at the time of system installation. The following two tools are made available:

[Unit Scanning Tool]

Performs unit scanning and network settings. Using this tool, first scan the NX-100 units connected to the LAN for the system initial setting.

[System Setting Tool]

Performs settings of unit broadcast, contact, serial bridge, etc. It is possible to create the system setting file beforehand by entering a unit setting before installation.

2.1.2. Management Setting Program

Use this program to change previously set contents to match current system application requirements. Only the broadcast pattern settings, serial bridge and contact, and unit names can be changed using a portion of the functions of the System Setting Tool.

Note

The Unit Scanning Tool cannot be used.

2.2. Setting Items Table

	Setting Item	Installation Setting	Management Setting
Unit Scanning Tool	Unit scanning (See p. 3-11)	✓	—
	IP address (See p. 3-12)	✓	—
	Subnet mask (See p. 3-13)	✓	—
	Default gateway (See p. 3-13)	✓	—
System Setup Tool	Network (See p. 3-17)	✓	—
	Broadcast spec (See p. 3-19)	✓	—
	Broadcast pattern (See p. 3-21)	✓	✓
	Contact (See p. 3-24)	✓	✓
	Serial bridge (See p. 3-28)	✓	✓
	System (See p. 3-30)	✓	✓

3. SETTING PROCEDURE

Pattern 1: Initial On-Site Setup

(1) Unit Scanning (Network Setting)

- After scanning the unit using the Setup program's Unit Scanning Tool, set the IP address, default gateway, subnet mask, and unit name.
- Upload the network setting data.
- Save the network setting data in unit setting file format ([IP address].cfg).

(2) System Setting

Set non-network items using the System Setting Tool.
Manually add any units that could not be scanned, and enter their IP addresses and unit names.

Set the following items in the order listed:

- System: Set audio I/O unit names.
- Network: Set the port number.
- Broadcast Spec: Perform Broadcast Spec settings based on the network configuration. Before using this function, confirm the following information with network management personnel:
 - Usable bandwidth
 - Whether or not multicast streaming can be used
- Broadcast Pattern: Set the units to be connected in each broadcast pattern when activated by contact or the Operation program. (This setting not needed for units that will not be used in broadcast patterns.)
- Contact: Set the broadcast pattern to be activated when a contact is received, and the contact output for other connected units. Also, set the operation to be performed when contact output is activated by other units.
- Serial: Set the units to be connected and their serial ports when using the serial bridge function.

(3) Setting Upload

Upload the unit setting file in order to enable the settings set in Step (2) above.

Pattern 2: Uploading the programmed system setting file after scanning the connected units on-site.

(1) System Setting

Using the System Setting Tool, program all the units in the system, and enter their unit names and IP address numbers.

- System: Set audio I/O unit names.
- Network: Set the port number.
- Broadcast Spec: Perform Broadcast Spec settings based on the network configuration. Before using this function, confirm the following information with network management personnel:
 - Usable bandwidth
 - Whether or not multicast streaming can be used
- Broadcast Pattern: Set the units to be connected in each broadcast pattern when activated by contact or the Operation program. (This setting not needed for units that will not be used in broadcast patterns.)
- Contact: Set the broadcast pattern to be activated when a contact is received, and the contact output for other connected units. Also, set the operation to be performed when contact output is activated by other units.
- Serial: Set the units to be connected and their serial ports when using the serial bridge function.

(2) Saving Data Files

Save the data folder located in the Setup program's installation folder to the PC's hard disk drive or a connected external storage device. Also be sure to save backup copies.

(3) Unit Scanning (Network Setting)

- After installing the system's Setup program on-site, copy the contents of the data folder saved in Step (2) above to the data folder.
- After setting the network using the Unit Scanning Tool, upload the unit setting file using the System Setting Tool.

Important

When performing settings according to this procedure, the pre-programmed set system setting contents are erased if [Save in setting file format] is executed using the Unit Scanning Tool. To prevent this, take the following precautions:

- 1. After completing settings using the System Setting Tool, copy and save the data folder under a different name.**
If a data folder copy is saved, even when [Save in setting file format] is selected, it is possible to write the unit setting file into the NX-100 after recopying the previously saved and renamed folder to the data folder.
- 2. After performing settings using the Unit Scanning Tool, use the System Setting Tool only after uploading the settings, but without executing [Save in setting file format].**
This prevents the unit setting file in the data folder from being overwritten.

4. STARTUP

4.1. Starting the Installation Setting Program

Step 1. Either double-click on the Installation Setting Program icon that was created on the desktop during installation or directly double-click on the application [nx100_util.jar] installed in the Software folder. The User Authentication dialog will be displayed.

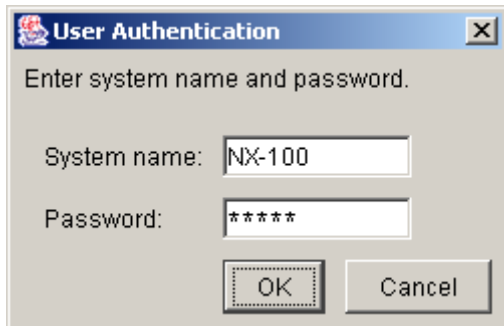

Step 2. Enter the system name and password, then press the OK button.

Note: Both the system name and password are case-sensitive.

The default system name is factory-preset to "NX-100" and the password to "guest."
To change them, refer to [p. 3-32](#).

When the system name and password are entered correctly, the initial Installation Setting Program screen is displayed.

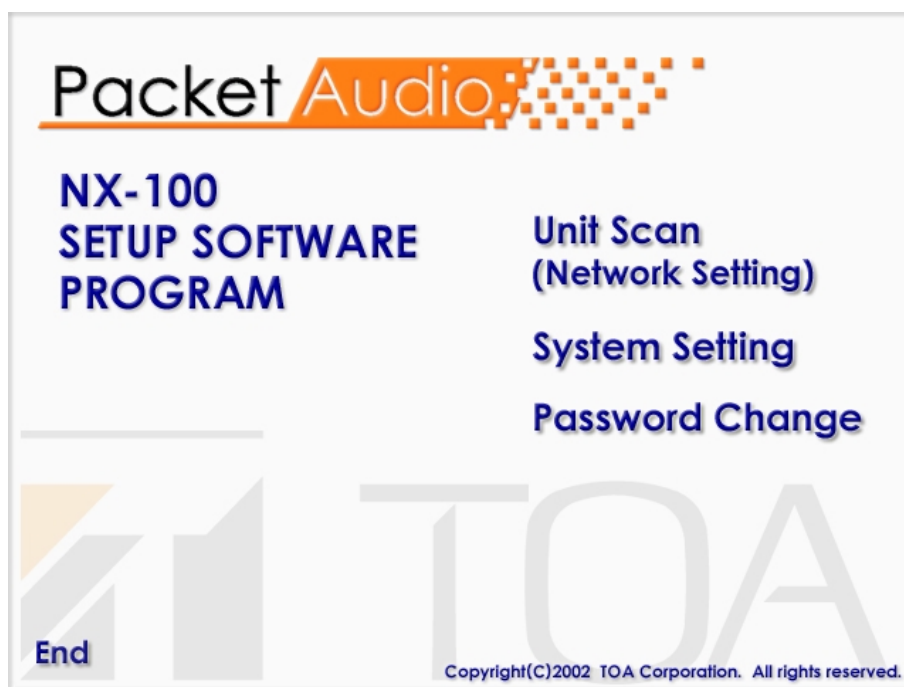

Tip

At startup, the Setup program automatically loads data related to unit setting from the data folder.

Step 3. When scanning the unit, click on [Unit Scan (Network Setting)].

Tip

When the settings are saved, a unit setting file is automatically created for each individual IP address and saved in the data folder. If a unit setting file of the same name already exists in the data folder, it is overwritten.

Step 4. Click on [System Setting] when performing such system settings as broadcast configuration.

Tip

When the settings are saved, a unit setting file is automatically created for each individual IP address and saved in the data folder. If a unit setting file of the same name already exists in the data folder, it is overwritten.

Step 5. Click on [Password Change] to change the password.

Step 6. Click on [End] to exit the program.

4.2. Starting the Management Setting Program

Step 1. Either double-click on the Management Setting Program icon that was created on the desktop during installation or directly double-click on the application [nx100_system.jar] installed in the Software folder.

The User Authentication dialog will be displayed.

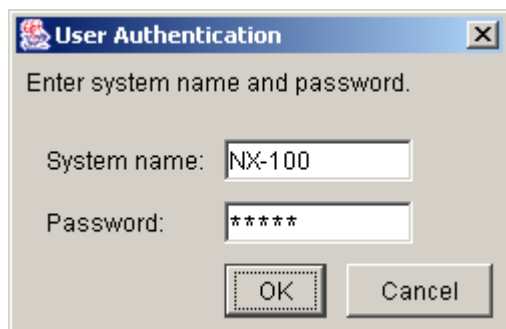

Step 2. Enter the system name and password, then press the OK button.

Note: Both the system name and password are case-sensitive.

The default system name is factory-preset to "NX-100" and the password to "guest."
To change them, refer to [p. 3-32](#).

When the system name and password are entered correctly, the initial Management Setting Program screen is displayed.

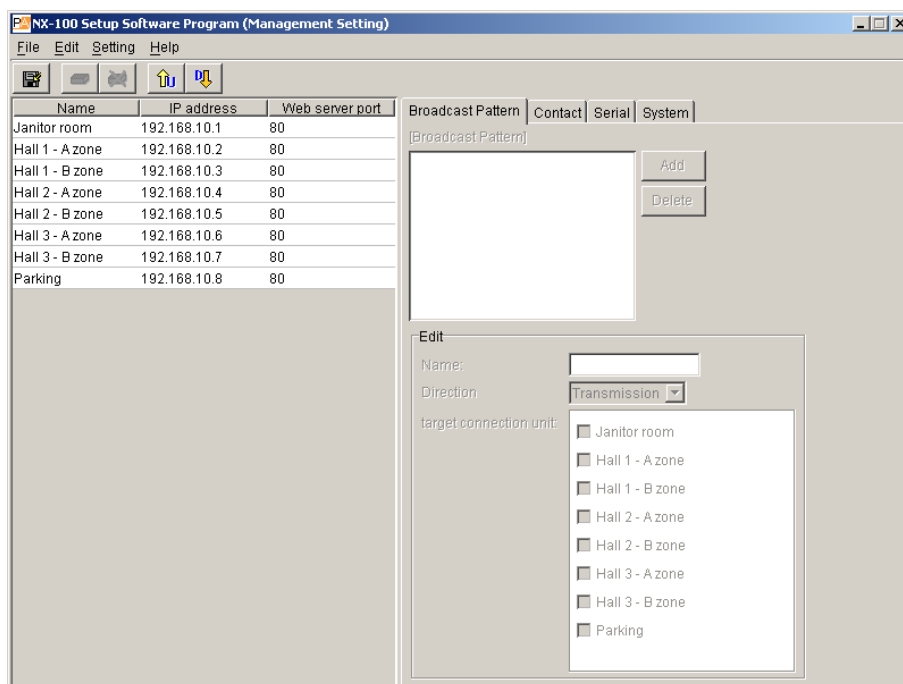

Tips

- At startup, the Setup program automatically loads data related to unit setting from the data folder.
- When the settings are saved, a unit setting file is automatically created for each individual IP address and saved in the data folder. If a unit setting file of the same name already exists in the data folder, it is overwritten.

5. UNIT SCANNING TOOL

Installation Setting Program only

Scans the units connected to the LAN.

Setting data can only be uploaded into the NX-100 units after each unit's IP address has been correctly set by way of either the Installation Setting Program's Unit Scanning Tool or a browser.

5.1. Screen Description

Click on [Unit Scan (Network Setting)] on the initial screen.

Shown below is an example of the screen displayed after the units have been scanned.

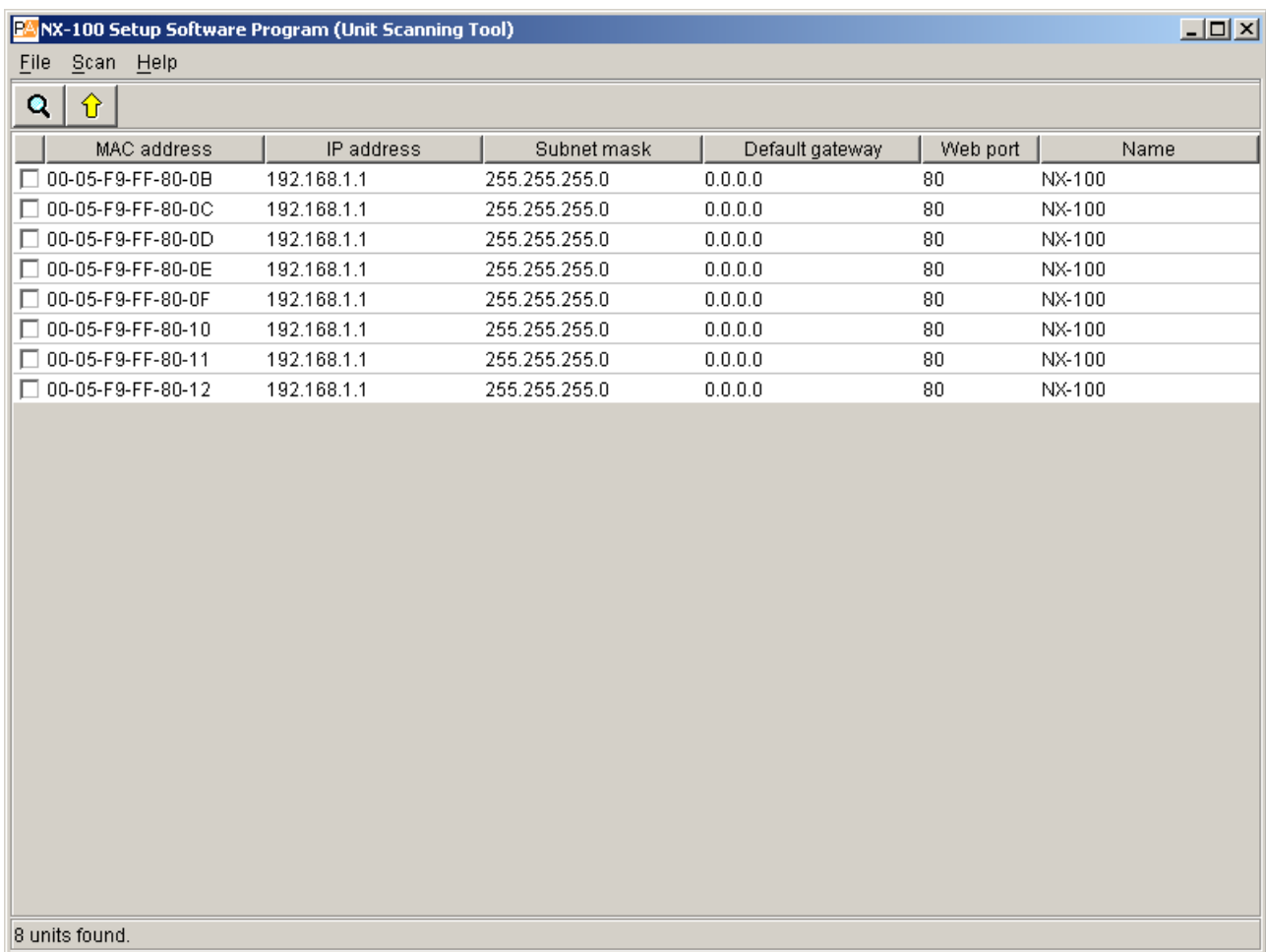

	MAC address	IP address	Subnet mask	Default gateway	Web port	Name
<input type="checkbox"/>	00-05-F9-FF-80-0B	192.168.1.1	255.255.255.0	0.0.0.0	80	NX-100
<input type="checkbox"/>	00-05-F9-FF-80-0C	192.168.1.1	255.255.255.0	0.0.0.0	80	NX-100
<input type="checkbox"/>	00-05-F9-FF-80-0D	192.168.1.1	255.255.255.0	0.0.0.0	80	NX-100
<input type="checkbox"/>	00-05-F9-FF-80-0E	192.168.1.1	255.255.255.0	0.0.0.0	80	NX-100
<input type="checkbox"/>	00-05-F9-FF-80-0F	192.168.1.1	255.255.255.0	0.0.0.0	80	NX-100
<input type="checkbox"/>	00-05-F9-FF-80-10	192.168.1.1	255.255.255.0	0.0.0.0	80	NX-100
<input type="checkbox"/>	00-05-F9-FF-80-11	192.168.1.1	255.255.255.0	0.0.0.0	80	NX-100
<input type="checkbox"/>	00-05-F9-FF-80-12	192.168.1.1	255.255.255.0	0.0.0.0	80	NX-100

8 units found.

(1) Scanned unit list

A list showing the units scanned.

(2) MAC address

Displays the MAC addresses of the units scanned.
Cannot be changed.

(3) IP address

Displays the IP addresses of the units scanned.

(4) Subnet mask

Displays the subnet mask to be set for the units scanned.

(5) Default gateway

Displays the default gateway to be set for the units scanned.

(6) Web port

Displays the port number of the web server.

(7) Name

Displays the names of the units scanned.

Note

When selecting a unit, tick the leftmost checkbox in the scanned unit list.

5.2. Menu

5.2.1. File

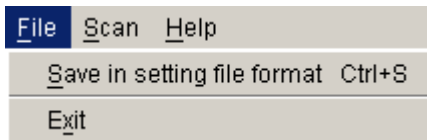

Save in setting file format (Ctrl+S): Saves scanned unit data to the PC in unit setting file format ([IP address].cfg)

Exit: Exits the program.

Important

The [Save in setting file format] function is used to set broadcasts in the system settings after the unit scan is complete. Selecting [Save in setting file format] writes the setting contents into the data folder. The contents of the unit setting file include only the IP address, subnet mask, default gateway, unit name, and Web server port number.

When broadcast contents have previously been set and saved using the System Setting Tool, these earlier system settings will be erased if [Save in setting file format] is selected.

If system setting has already been performed, take the following measures to prevent erasure of the setting contents:

1. Upon completion of System Setting Tool settings, copy and save the data folder under a different name.

If the data folder is copied, the unit setting file can be written into the NX-100 after copying the renamed folder to the data folder, even when [Save in setting file format] is selected.

2. After Unit Scanning Tool settings have been performed, use the System Setting Tool after uploading the settings, but without executing [Save in setting file format].

This prevents the unit setting file in the data folder from being overwritten.

5.2.2. Scan

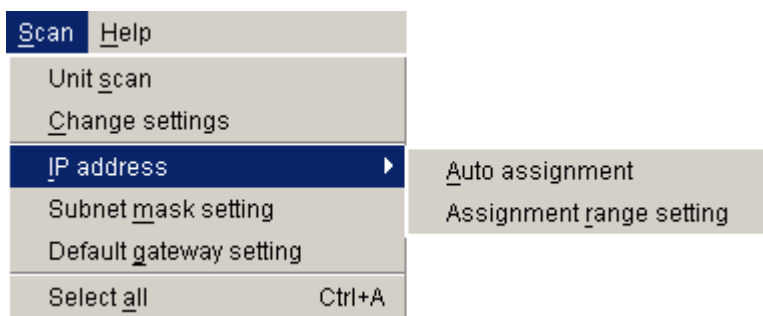

Unit scan: Scans the units connected to the LAN.

Change settings: Uploads the settings of the selected unit.

IP address: Automatically assigns an IP address and performs related settings.

Auto assignment: Automatically assigns an IP address to the selected unit.

Assignment range setting: Sets the IP address range to be used in automatic IP address assignment.

Subnet mask setting: Sets the same subnet mask to the selected units.

Default gateway setting: Sets the same default gateway to the selected units.

Select all (Ctrl+A): Selects all of the units scanned.

5.2.3. Help

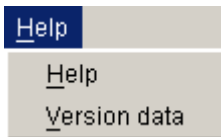

Help: Displays help contents.

Version data: Indicates the version of the program in use.

5.3. Buttons



(1) (2)

(1) Unit scan button: Scans all the units on the LAN.

(2) Setting upload button: Writes the IP address, subnet mask, default gateway, and name into the selected units.

5.4. Scanning Units

Scans each unit connected to the LAN.

Step 1. Connect an NX-100 to the network and turn on its power.
The LNK/ACT Indicator will light.

Step 2. Either press the Unit Scan Button  or select [Scan] → [Unit scan].

The MAC address, IP address, subnet mask, default gateway, and unit name of the NX-100 connected to the LAN will be displayed.

Default values are factory-preset as follows:

IP address:	192.168.1.1
Subnet mask:	255.255.255.0
Default gateway:	0.0.0.0
Name:	NX-100

Caution

Units can only be scanned within the effective broadcast range. (See [p. 6-3](#).)

For the units that cannot be scanned, manually add only the units connected to the LAN with the System Setting Tool.

5.5. Changing the Unit Setting Values

Change the unit's setting values individually.

Step 1. Double-click on the desired cell.
Data can be entered.

Step 2. Enter a new value.

Step 3. Press the Enter key or click on another cell.

Step 4. After editing completion, press the Upload Button .

Caution

Since the NX-100 is automatically reset after uploading, any broadcasts currently in progress are stopped.

5.6. Automatic IP Address Assignment

Set the IP address for the unit scanned.

Besides the "Changing the Unit Setting Values" method described in the previous item, there is another method for automatically assigning addresses by limiting the IP address setting range.

Step 1. Select the unit to which the address is assigned by ticking its selection checkbox.
To assign the same address to all units, select [Scan] → [Select all].

Step 2. Select [Scan] → [IP address] → [Assignment range setting] to set the usable IP address range.

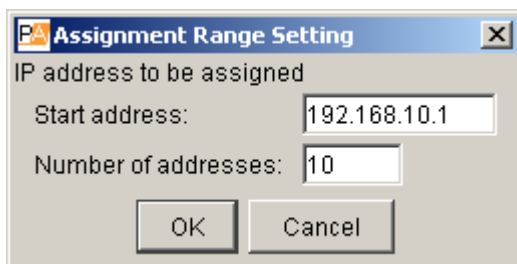

Setting the range permits the selection of [Scan] → [IP address] → [Automatic assignment].

Step 3. Select [Scan] → [IP address] → [Automatic assignment].
The IP addresses are automatically assigned without duplicating.

5.7. Subnet Mask and Default Gateway Settings

The same subnet mask and default gateway numbers can be set for all selected units.

- Step 1.** Tick the selection checkbox to select the unit.
To select all units, select [Scan] → [Select all].

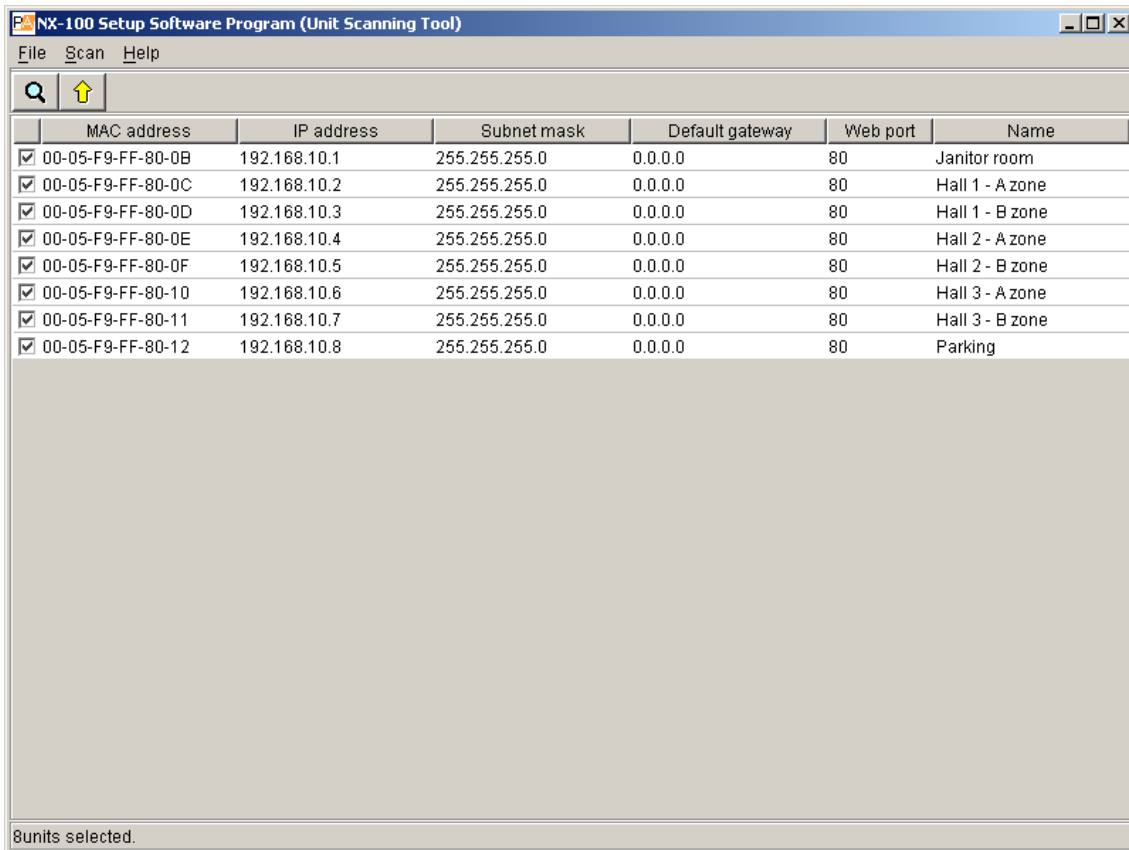

- Step 2.** Set the subnet mask.

2-1. Select [Scan] → [Subnet mask setting].

2-2. A dialog will be displayed. Enter the setting value and click on the OK button.

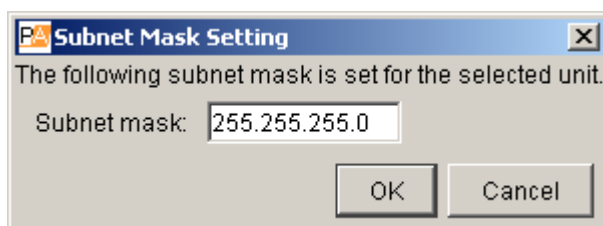

- Step 3.** Set the default gateway.

2-1. Select [Scan] → [Default gateway setting].

2-2. A dialog will be displayed. Enter the setting value and click on the OK button.

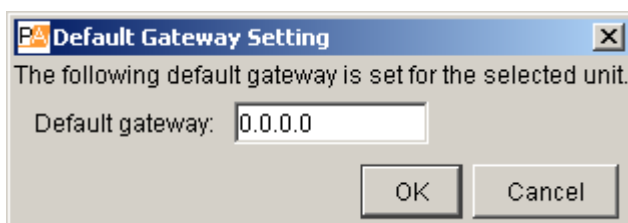

6. SYSTEM SETTING TOOL

Setting data can only be updated after the unit's IP address has been correctly set by way of either the Installation Setting Program's Unit Scanning Tool or a browser.

6.1. Screen Description

Clicking on [System Setting] on the Installation Setting Program's initial screen displays the following window. The same window is directly displayed in the Management Setting Program when started. Network and Broadcast Spec settings cannot be performed using the Management Setting Program. If the unit to be set is selected, its currently set contents are displayed in the right-side setting form.

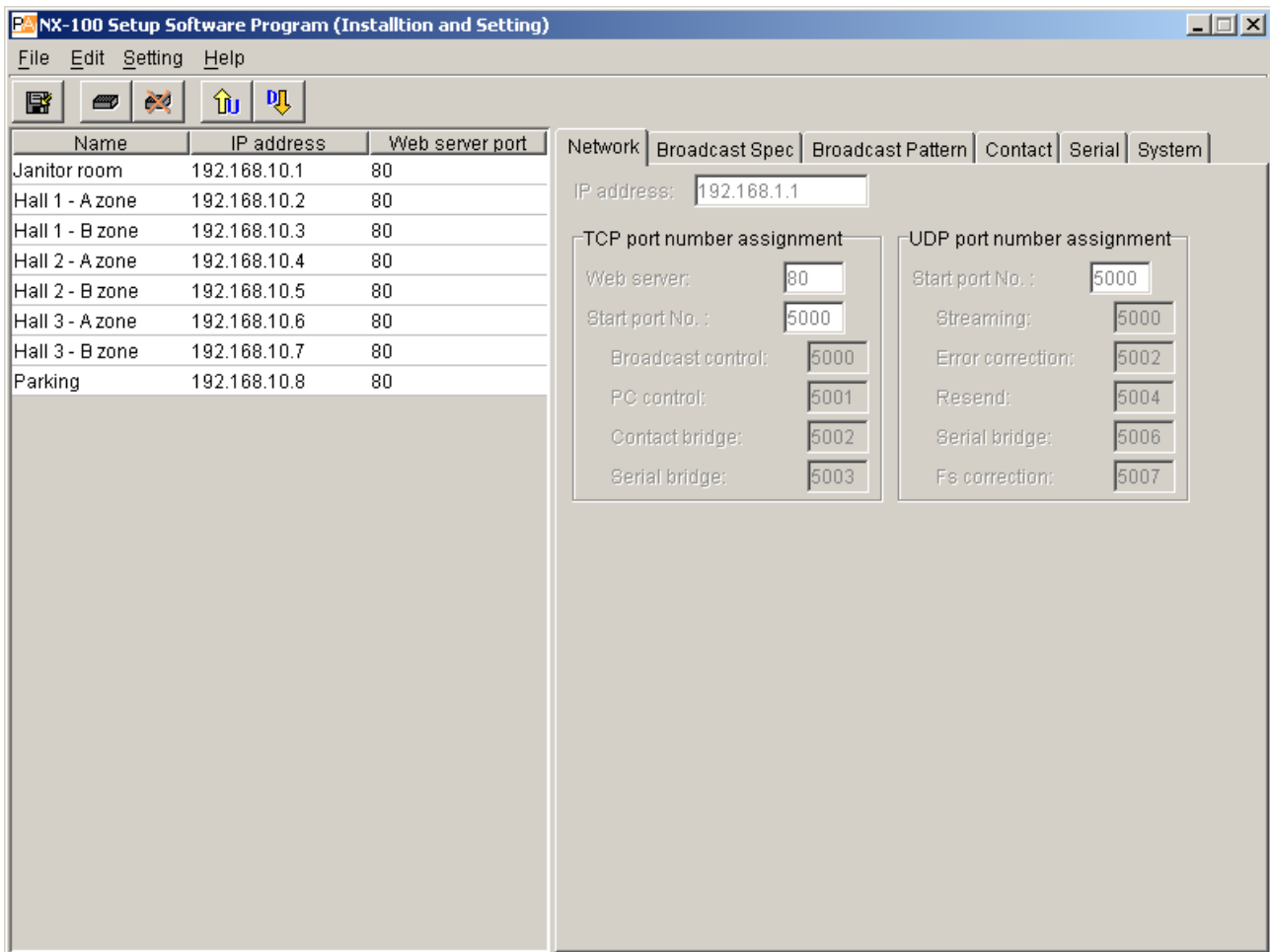

- (1) **Name**
Displays the unit names programmed into the system.
- (2) **IP address**
Displays the unit IP addresses programmed into the system.
- (3) **Web server port**
Displays the port number of the web server.

6.2. Menu

6.2.1. File

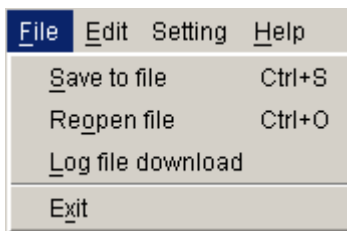

Save to file (Ctrl+S): Overwrites and saves the system setting file.

Reopen file (Ctrl+O): Rereads the saved system setting file.

Log file download: Saves the log of all NX-100 operations programmed into the system.

Exit: Exits the program.

6.2.2. Edit

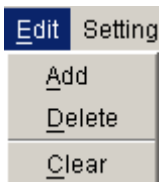

Add: Adds the selected NX-100 to the list (edit screen).

Delete: Deletes the selected NX-100 from the list (edit screen).

Clear: Deletes all NX-100 units from the list (edit screen).

6.2.3. Setting

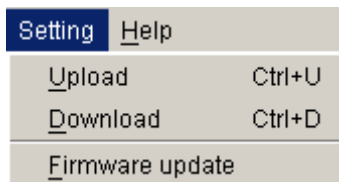

Upload (Ctrl+U): Writes the settings currently being edited into the NX-100.

Download (Ctrl+D): Downloads the settings from the NX-100 and displays them on the edit screen. (Not saved.)

Firmware update: Updates the NX-100 firmware.

6.2.4. Help

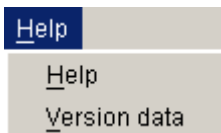

Help: Displays help contents.

Version data: Verifies the version number of the NX-100 Setup program. When it is the Management Setting program, a system name and password can be changed.

6.2.5. Buttons



(1) **(2)** **(3)** **(4)** **(5)**

- (1) Save button: Saves and overwrites the system setting file.
- (2) Add button: Adds NX-100 units to the network list (edit screen).
- (3) Delete button: Deletes NX-100 units from the network list (edit screen).
- (4) Upload button: Writes the currently edited settings into the corresponding NX-100.
- (5) Download button: Downloads NX-100 settings and displays them on the edit screen. (Not saved.)

6.3. Network Setting Installation Setting Program only

Step 1. Click on the [Network] tab of the System Setting Tool.
The setting screen will be displayed.

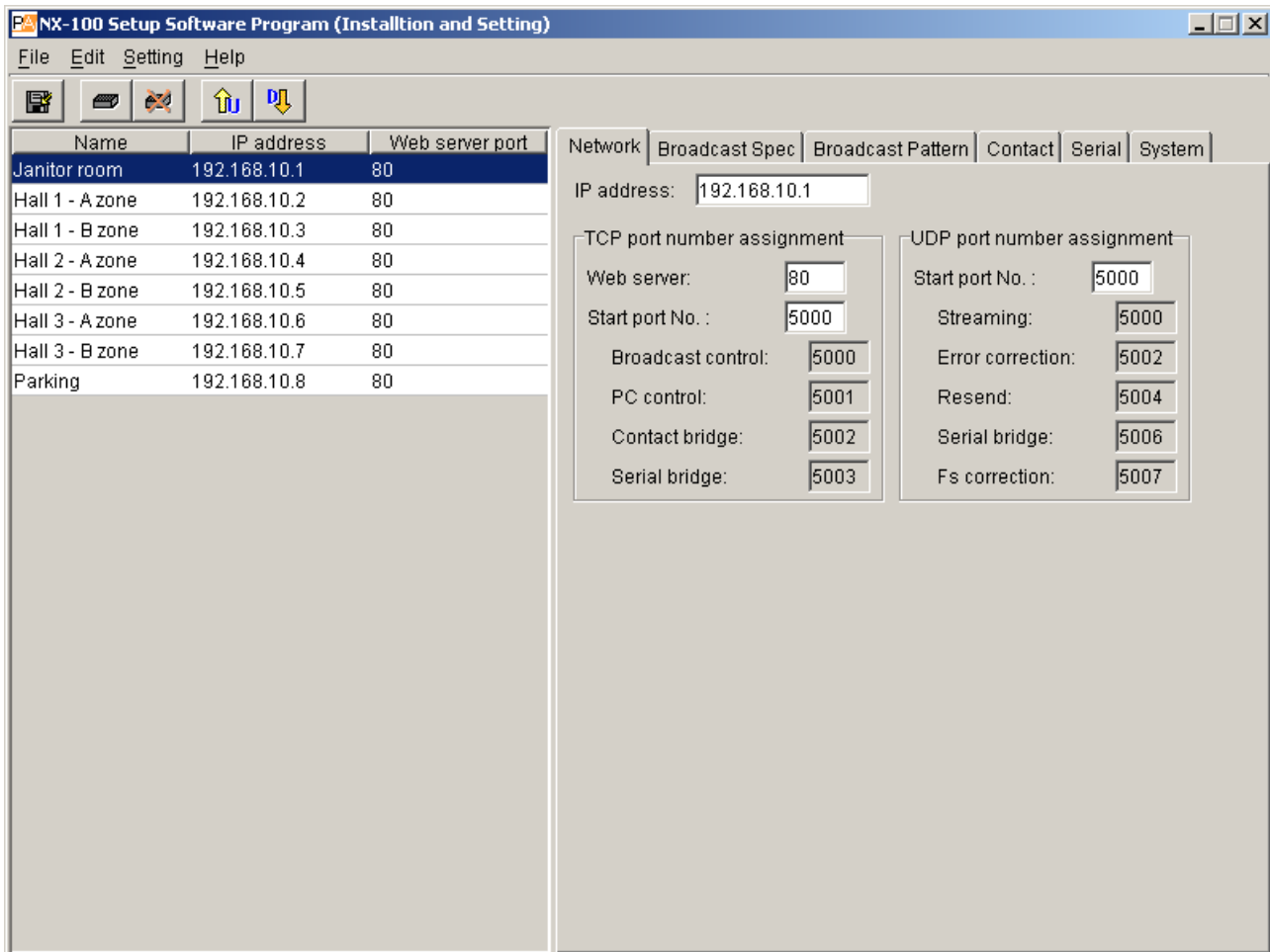

Step 2. Set each item.

(1) IP address

Enter the unit's IP address. After the IP address is set with the Unit Scanning Tool, the assigned IP address is indicated when the unit setting file is loaded into the PC.

(2) TCP port number assignment

Designate the web server port number and the base number of the other TCP port. The port number can be set within the range of 1 – 65535.

[Web server]

Enter the web server port number. Its default is "80."

[Start port No.]

Enter the base number of the TCP port (other than web server, which is used by the unit). The default is "5000." Enter the number from within the range of 1 – 65532.

The TCP ports are assigned as follows:

Port	Protocol	Port No.	Default
Web server	TCP	Web server	80
Broadcast control	TCP	Start port No. + 0	5000
PC control	TCP	Start port No. + 1	5001
Contact bridge	TCP	Start port No. + 2	5002
Serial bridge	TCP	Start port No. + 3	5003

(3) UDP port number assignment

Designate the base port number to be used by UDP.

[Start port No.]

Enter the base UDP port number to be used by the unit. The default is "5000." Enter an even number from within the range of 1 – 65526.

The UDP ports are assigned as follows:

Port	Protocol	Port No.	Default
Streaming	UDP	Start port No. + 0	5000
Error correction	UDP	Start port No. + 2	5002
Resend	UDP	Start port No. + 4	5004
Serial bridge	UDP	Start port No. + 6	5006
Fs* correction	UDP	Start port No. + 7	5007

* Sampling frequency

Caution

Since UDP port No. 15000 is used by the unit, numbers between 14990 and 15000 cannot be used.

6.4. Broadcast Spec Setting Installation Setting Program only

- Step 1.** Click on the Broadcast Spec tab of the System Setting Tool.
The setting screen will be displayed.

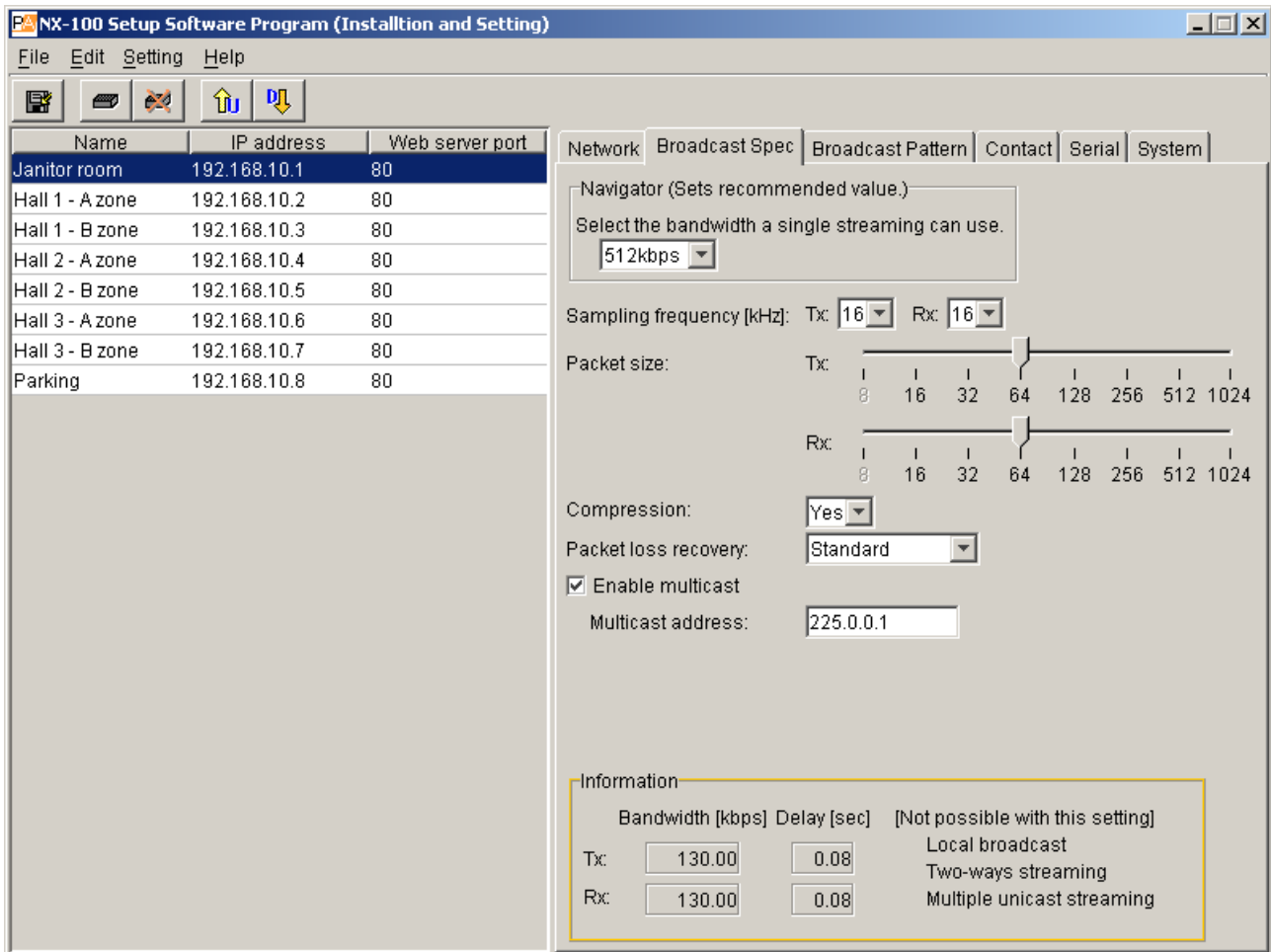

- Step 2.** Select the usable bandwidth at Navigator.
Selection of the usable bandwidth automatically sets recommended values except those related to Multicast. If no problems are foreseen, perform the setting as is, without changing this value.

Note

For bandwidth and multicast streaming, consult with on-site network management personnel.

- Step 3.** Set each item while referring to the bandwidth and delay time indicated in the Information area located at the bottom of the screen.

Caution

Broadcasts are interrupted when the set bandwidth is displayed in red in the Information area. (The bandwidth is indicated in red whenever this setting exceeds the per-stream usable bandwidth.)

(1) Sampling frequency [kHz]

Select a sampling frequency for both transmission and reception from [8], [16], and [32] kHz. Sound quality improves with higher sampling frequencies, however this makes the usable bandwidth wider.

Caution

Local broadcasts are disabled if a transmission sampling frequency of [32] kHz is selected (refer to broadcasting direction in ["the Broadcast Pattern Setting" on p. 3-22](#)).

(2) Packet size

Select the size of audio packet.

The packet size cannot be changed when [Resend] is selected in the Packet loss recovery item. Smaller packet sizes result in a wider bandwidth, however delay times become shorter.

(3) Compression

Select [Yes] or [No]. Audio signal compression narrows the bandwidth. To narrow the bandwidth of the network, it is highly recommended that compression be enabled.

(4) Packet loss recovery

Selects one of three recovery methods used when an audio packet is lost: [Standard], [Error Correction], and [Resend]. Refer to p. 6-4 for details regarding each recovery method.

[If "Error Correction" is selected]

A scale for setting the correction level appears. Higher settings increase correction capability, however delay times are also made longer.

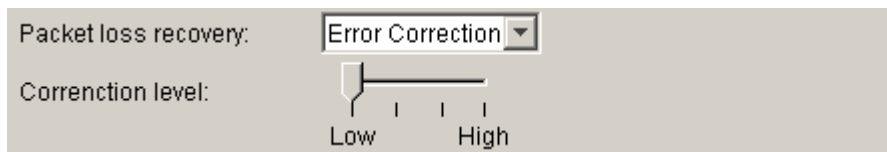
**[If "Resend" is selected]**

A scale for setting delay times appears. Longer delay times increase correction capability.

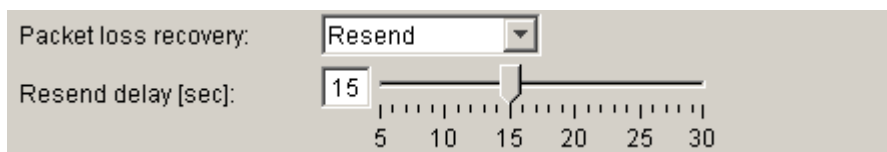
**(5) Enable multicast and Multicast address**

Set whether or not to use multicast for broadcasts. Ticking the [Enable multicast] checkbox makes it possible to enter the multicast address. The effective address range is from (225.0.0.0) to (238.255.255.255).

Note

Be sure to consult with network management personnel before performing this setting.

6.5. Broadcast Pattern Setting

6.5.1. Setting new broadcast patterns

Step 1. Click on the [Broadcast Pattern] tab of the System Setting Tool.
The setting screen will be displayed.

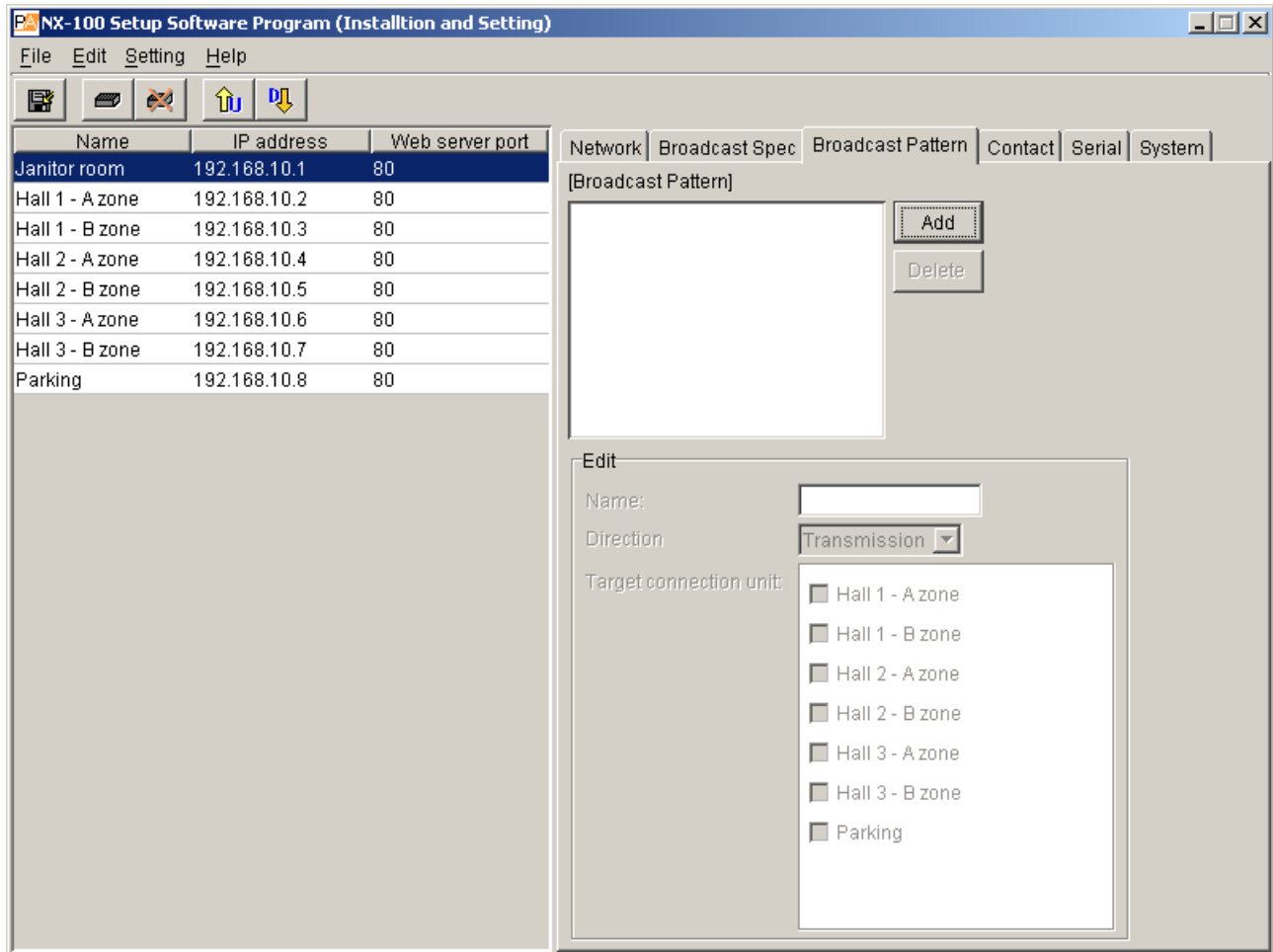

- Step 2.** Press the Add button.
The edit area becomes available for editing.

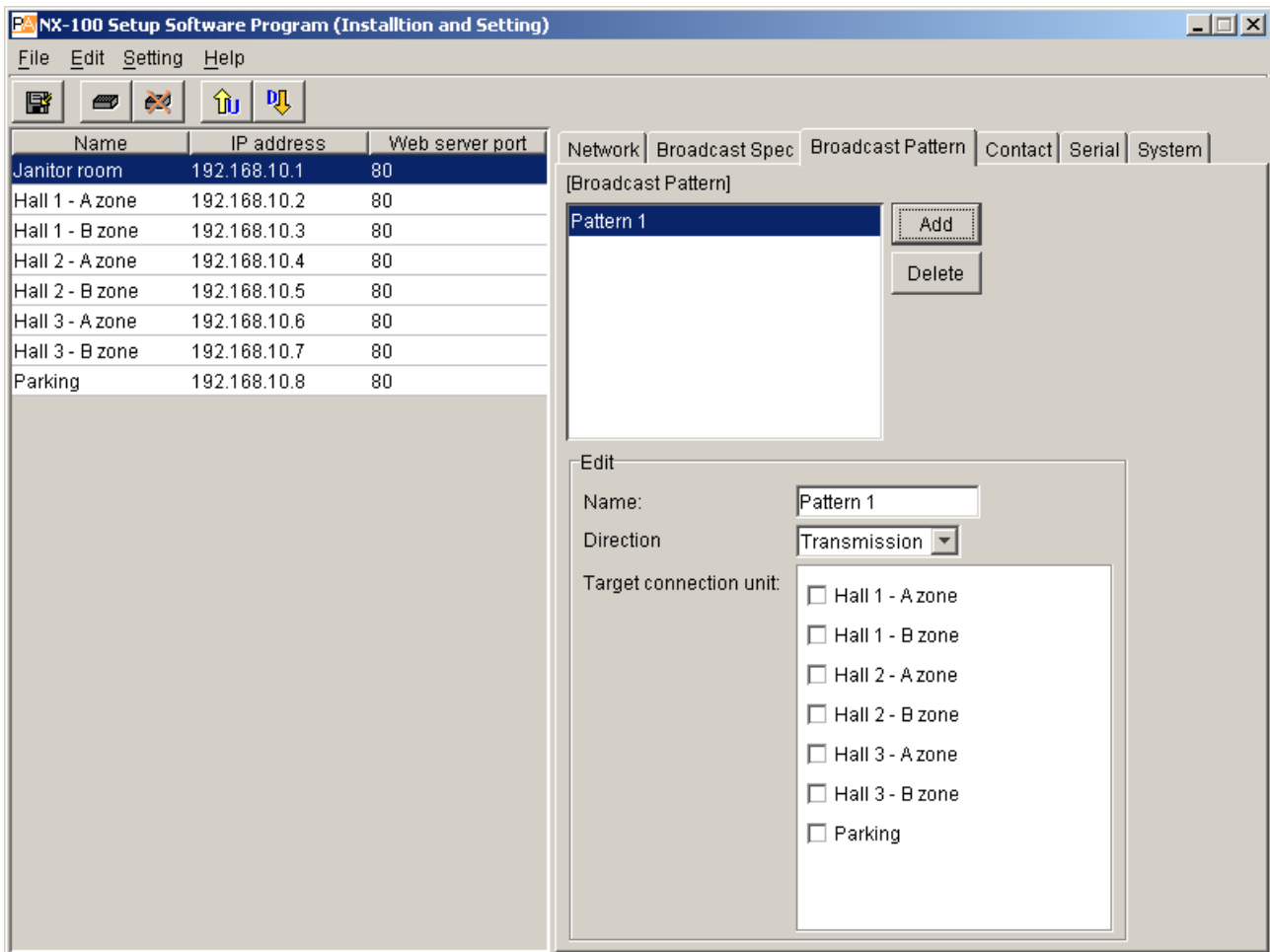

- Step 3.** Enter a broadcast pattern name.

Caution

Avoid assigning a name already programmed.

- Step 4.** Select the broadcasting direction from [Transmission], [Reception], and [Local].

Transmission: Transmits broadcast signals to the connected NX-100 units.

Reception: Receives broadcast signals from the connected NX-100 unit.

Local: Makes broadcasts from the Audio Input of the NX-100 unit to its Audio Output.

Selecting [Transmission] or [Reception] permits selection of the connected unit.

Caution

[Local] broadcasts cannot be made when the transmission sampling frequency is set to 32 kHz in the Broadcast Spec setting.

- Step 5.** Select the connected unit from the displayed list (when [Transmission] or [Reception] is selected)

Cautions

- Only those units connected to the LAN can be selected.
- Only one location can be selected when the multicast function is not used. (Also one location for reception.)
- Only units designated for multicast streaming can be group-selected.

6.5.2. Editing broadcast patterns

Step 1. Click on the [Broadcast Pattern] tab of the System Setting Tool.
The setting screen will be displayed.

Step 2. Click on the broadcast pattern to be edited.
The setting contents are displayed in the edit area, allowing editing.

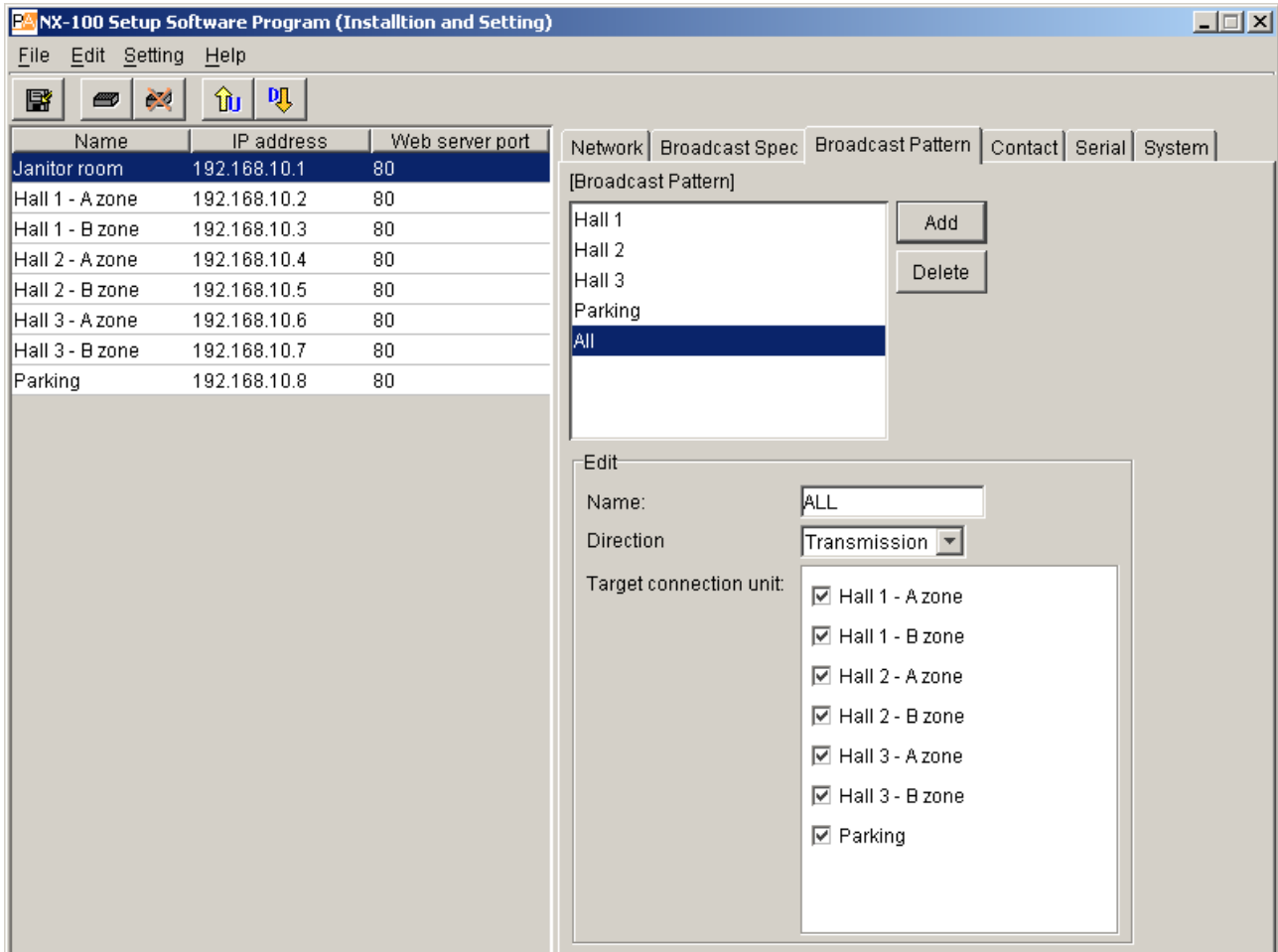

Tip

To delete a previously programmed broadcast pattern, click on the broadcast pattern to be deleted, then press the Delete button.

Step 3. Re-enter or reselect the section to be changed.

6.6. Contact Setting

6.6.1. Contact input setting

Step 1. Click on the [Contact] tab of the System Setting Tool.

Step 2. Click on the selection button for the contact input channel number.
The setting contents will be displayed.

Step 3. Tick the [Enable contact] checkbox.
The setting contents can be edited.

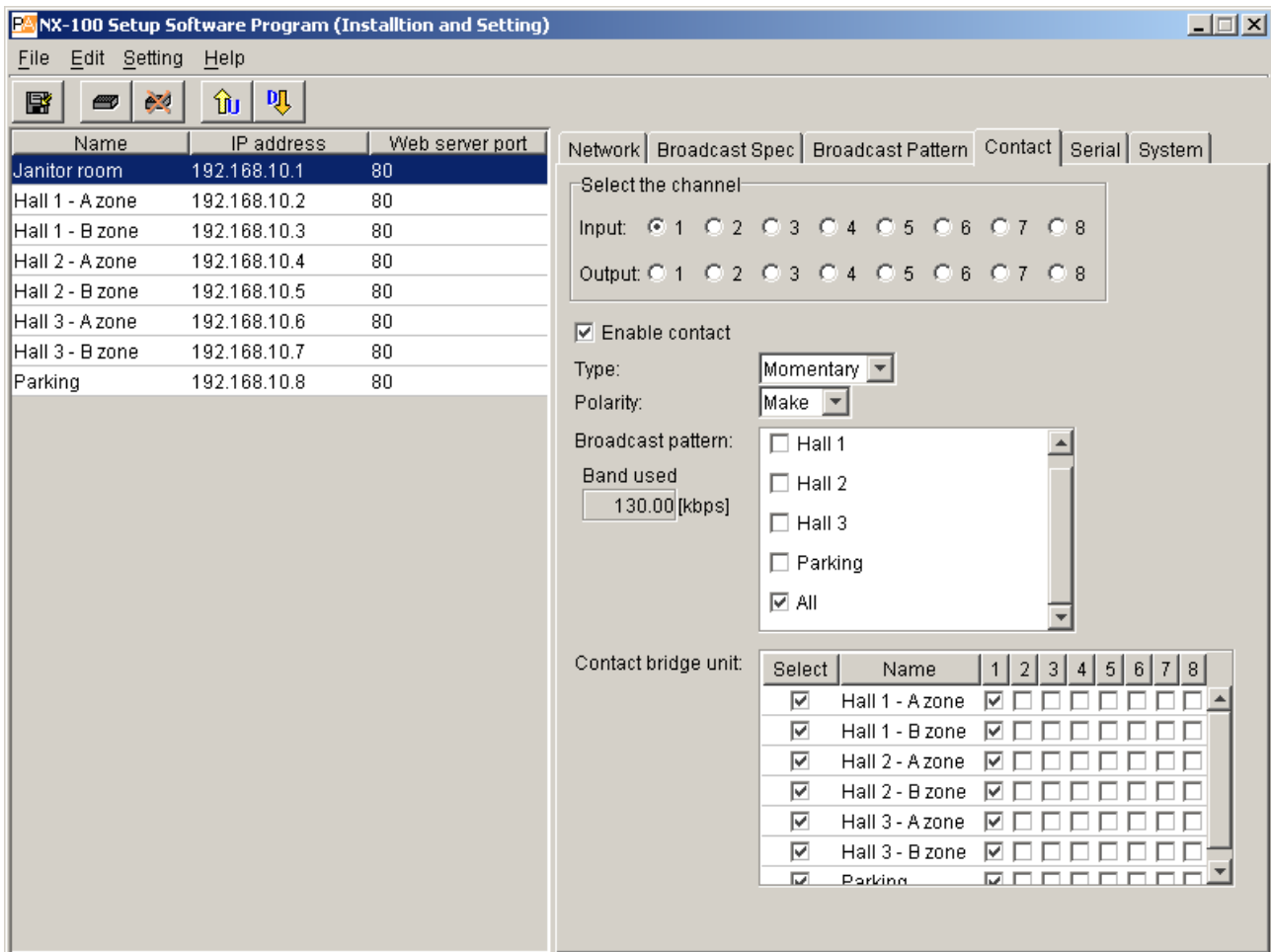

Step 4. Set the type to [Momentary] or [Latch].

Momentary: The designated broadcast pattern or other unit's contact output is activated during the interval that input is ON. Activation stops while the input is OFF.

Latch: The designated broadcast pattern or other unit's contact output is activated when the input is turned ON, and the activation mode continues even if the input is turned OFF. Activation stops when the input is turned ON again.

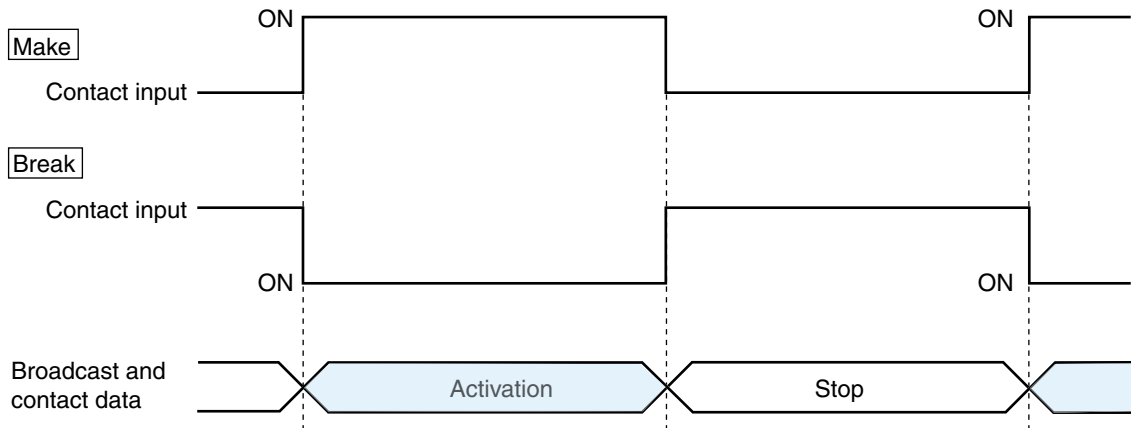
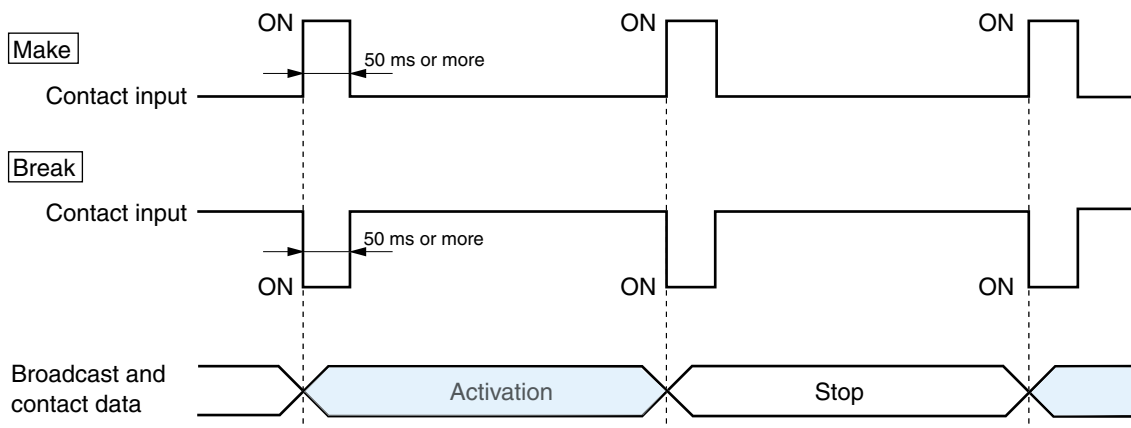
• Momentary**• Latch****Step 5.** Set Polarity to [Make] or [Break].

Make: ON when the contact is closed.

Break: ON when the contact is opened.

Step 6. A list of the programmed broadcast patterns is displayed in the [Broadcast pattern] screen. Tick the checkbox to select the pattern.**Cautions**

- Broadcasts cannot be made if the set frequency band exceeds the usable bandwidth.
- Up to 4 broadcast patterns can be selected for transmission, and 1 pattern for reception. (Only 1 pattern for multicast streaming.)
- When no broadcast pattern is displayed, no broadcast patterns are programmed. In such cases, create new patterns on the Broadcast Pattern setting tab screen.

Step 7. Click to select the connected unit from the [Contact bridge unit] list.**Cautions**

- Only those units connected to the LAN can be selected.
- Up to 64 locations can be selected.

6.6.2. Contact output setting

- Step 1.** Click on the [Contact] tab of the System Setting Tool.
- Step 2.** Click on the selection button for contact output channel numbers.
The setting contents will be displayed.
- Step 3.** Tick the checkbox for [Enable contact].
The setting contents can be edited.

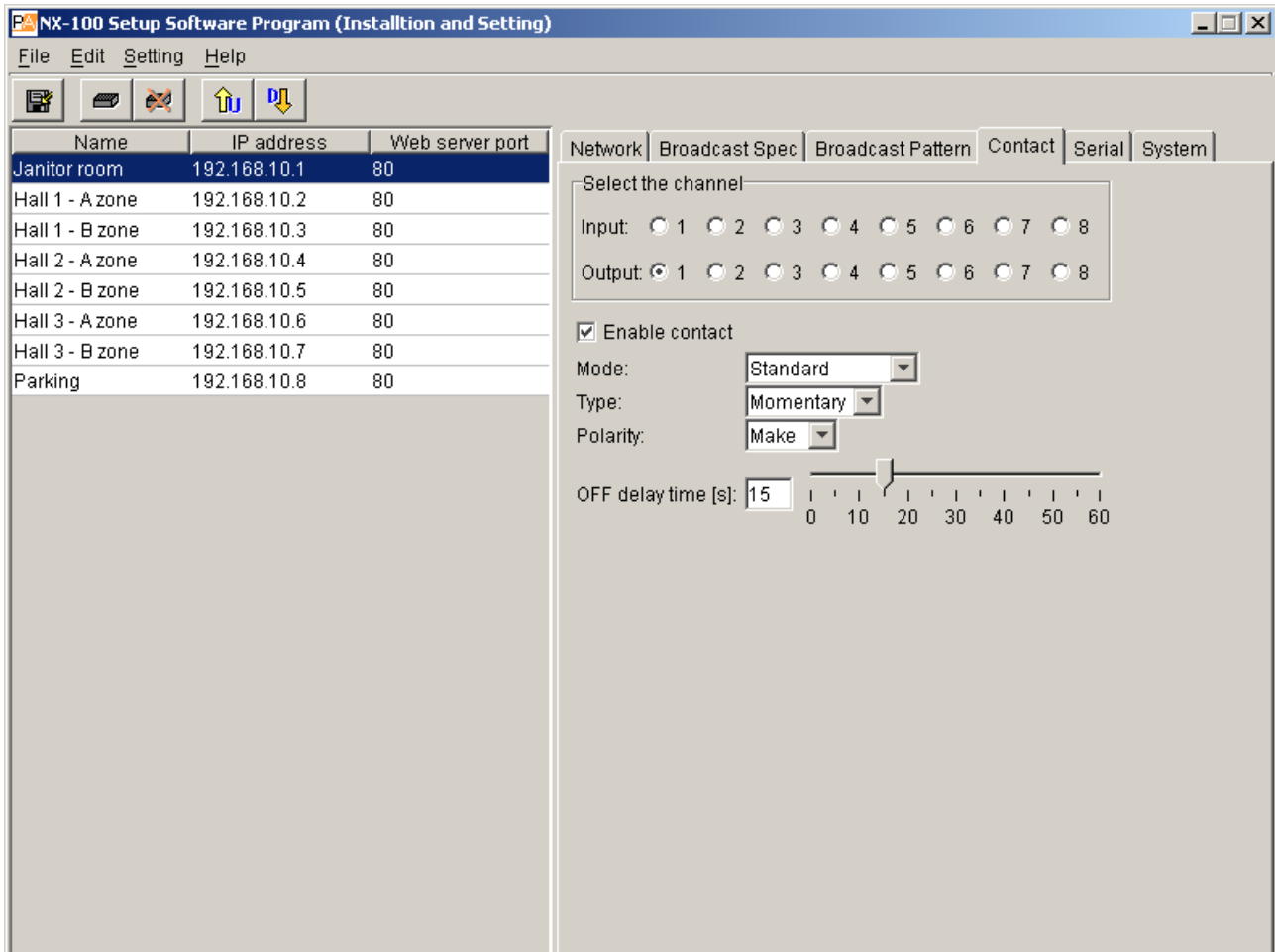

- Step 4.** Select Mode from [Standard], [STATUS Output], and [ERROR Output].
- Standard: Provides output by way of control from a PC or contact inputs of other units or original unit.
- STATUS Output: Provides output synchronizing with the STATUS indicator operation.
- ERROR Output: Provides output synchronizing with the ERROR indicator operation.
- Note:** To use the Contact bridge function, select [Standard].

Step 5. Set the type to [Momentary] or [Latch].

Momentary: Provides output during the period between receiving an activation request and receiving a stop request.

Latch: Provides 1 second of output upon receiving an activation request and 1 second of output upon receiving a stop request.

Note

[Latch] cannot be selected when setting Mode to [STATUS Output] or [ERROR Output].

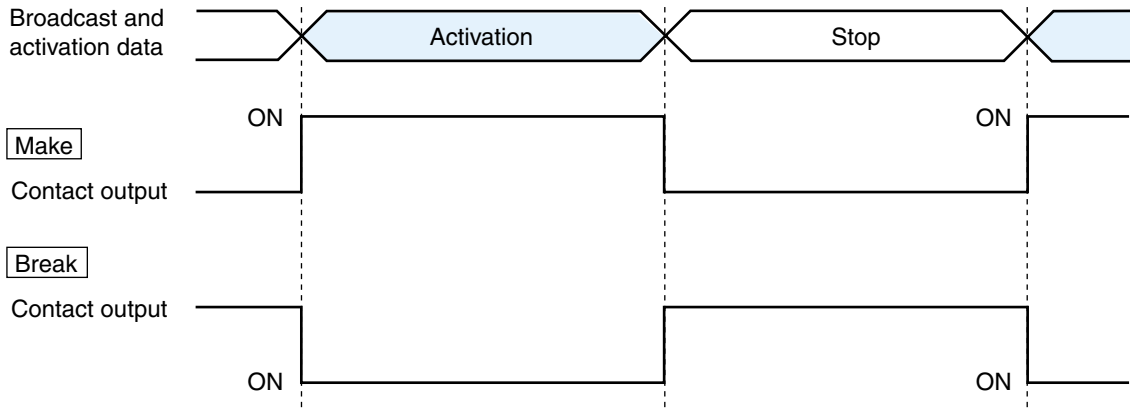
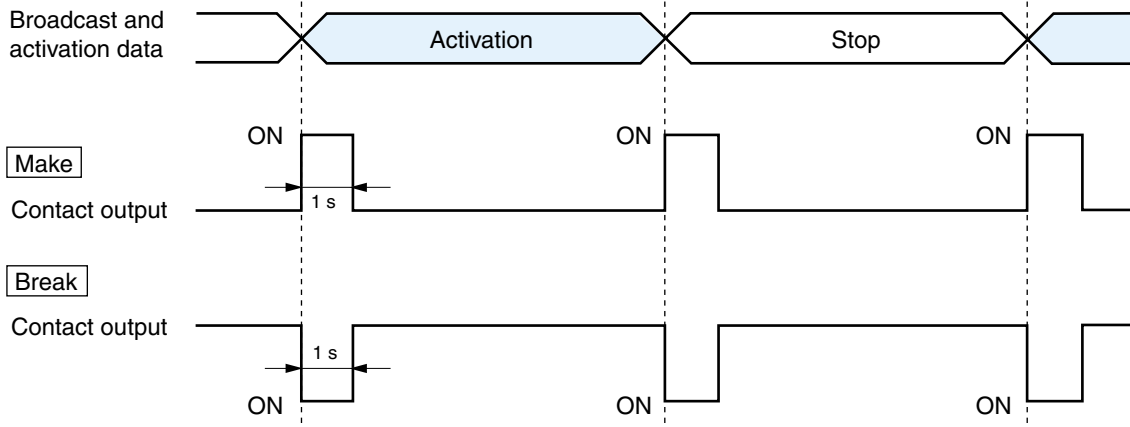
• Momentary**• Latch****Caution**

The unit's correct operation cannot be ensured if both activation and stop signals are received during the 1-second output interval.

Step 6. Select Polarity from [Make] or [Break].

Make: ON when the contact is closed.

Break: ON when the contact is opened.

Step 7. Set OFF delay time from [0] – [60] seconds.

Adjust the displayed scale or enter an OFF delay time of 0 – 60 seconds for the duration between receiving a termination request and actually turning OFF the contact. When in Resend mode (refer to p. 3-20, Packet loss recovery) and making broadcasts with longer delay times, set the OFF delay time to correspond to the delay time.

Note

For more information regarding OFF delay times, refer to p. 6-4.

6.7. Serial Bridge Setting

Step 1. Click on the [Serial] tab of the System Setting Tool.

Step 2. Tick [Enable serial port].

The setting screen will be displayed, allowing entry of each item.

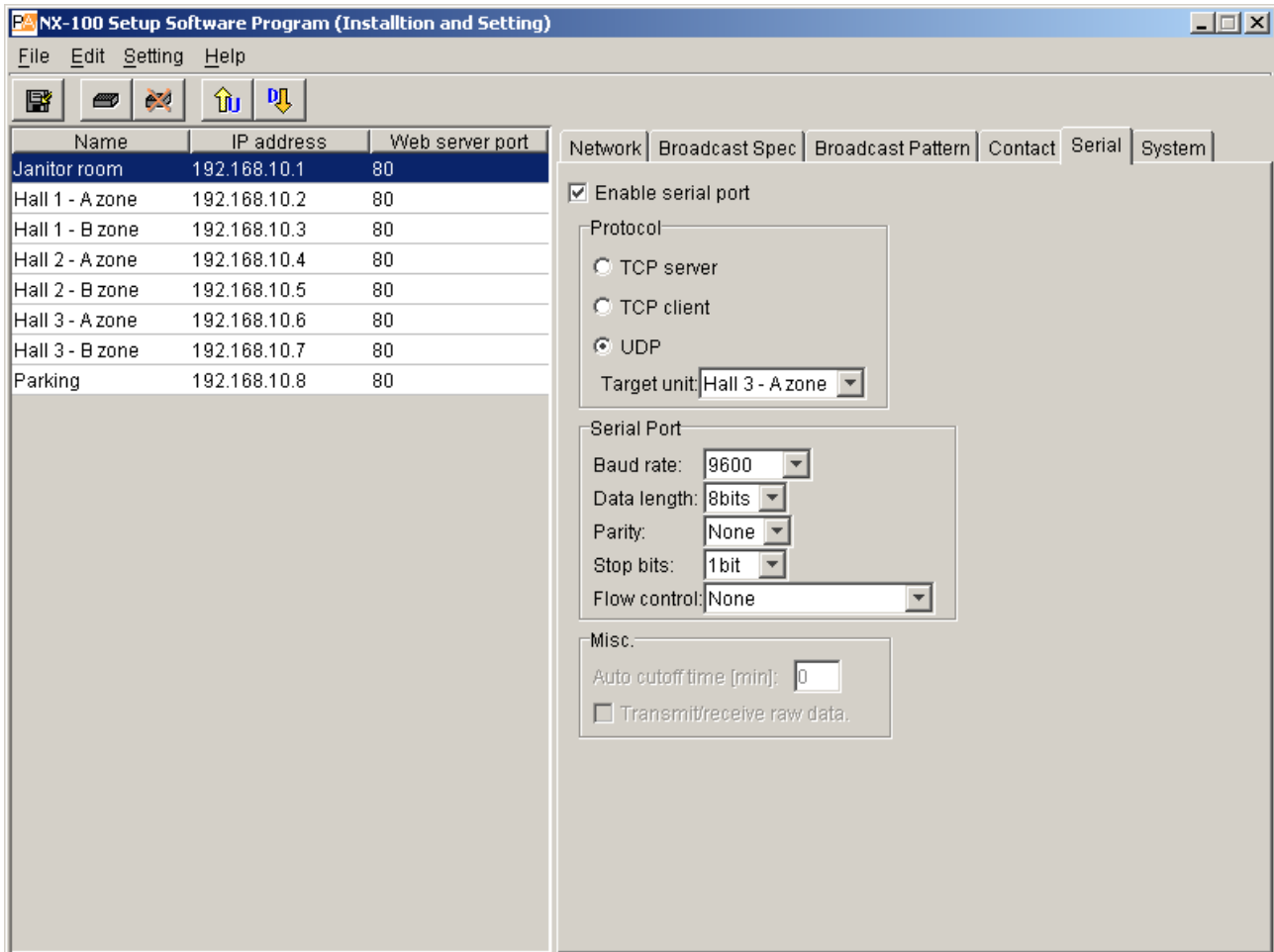

Step 3. Set each item.

(1) Protocol

Select the serial bridge communication method.

TCP server: The unit selected on the setting screen functions as a TCP server and carries out communications.

TCP client: The unit selected on the setting screen functions as a TCP client and carries out communications. Clicking the radio button permits selection of the connected unit.

UDP: Carries out UDP communications. Clicking the radio button permits selection of the connected unit.

(2) Target unit

Select the unit to be connected.

Caution

Only units connected to the LAN can be selected.

(3) Baud rate

Select [9600], [19200], [38400], [57600] or [115200]

(4) Data length

Set to either [7 bits] or [8 bits].

(5) Parity

Select [Even], [Odd] or [None].

(6) Stop bits

Select [1 bit] or [2 bits].

(7) Flow control

Select the type of flow control.

None: Flow control is not performed.

Xon/Xoff: Performs software flow control.

Hardware: Performs hardware flow control.

(8) Auto cutoff time (minutes)

Set the time interval (timeout duration: 0 – 60 minutes) before the connected unit is automatically disconnected following the end of the last communication. The connected unit is not disconnected if the timeout duration is set to [0]. This function is only available for TCP connections.

(9) Transmit/receive raw data

Tick the checkbox when transmitting and receiving raw data. Data with control information to be utilized between NX-100 units is usually transmitted, but raw data communications are generally carried out without such control information. However, when communications with other connected units are cut off, this cannot be detected. Raw data communications are only possible while in TCP connection mode.

6.8. System Settings

- Step 1.** Click on the [System] tab of the System Setting Tool.
The setting screen will be displayed.

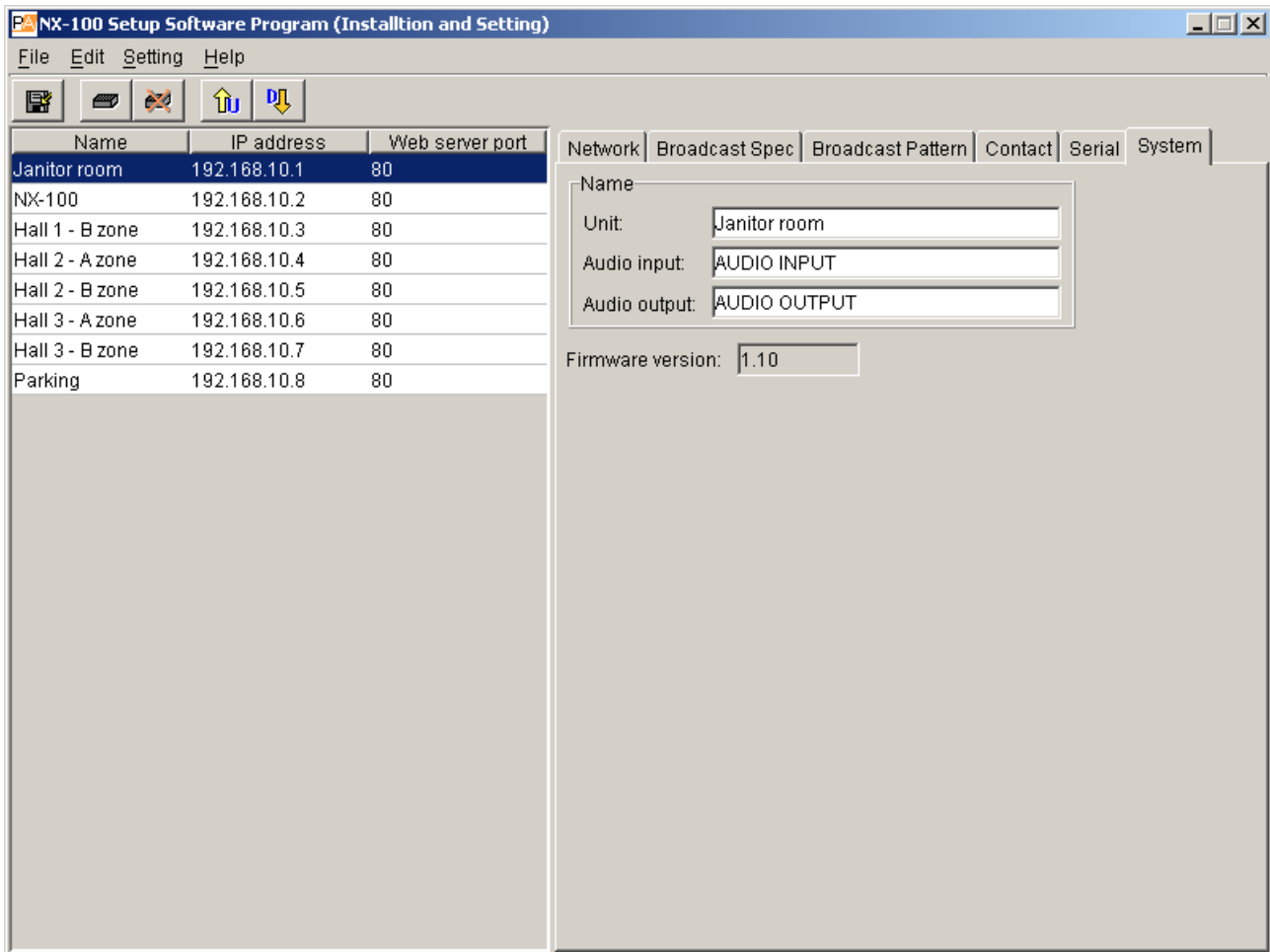

- Step 2.** Perform settings for each item.

(1) Unit

Enter the unit name.

(2) Audio input

Enter the name of the audio input unit connected to the NX-100 unit.

(3) Audio output

Enter the name of the audio output unit connected to the NX-100 unit.

(4) Firmware version

Indicates the unit's firmware version number.

6.9. Saving the Unit Setting Files

Save the unit setting file to the specified location.*

* The data folder is located in the installation folder (Default path: C:\Program Files\TOA\NX-100) of the setup program. The save location cannot be manually designated.

Click on the Save button  or select [File] → [Save].

6.10. Reopening Unit Setting Files

Reopen the saved unit setting files.

The program automatically reads the saved unit setting files at the time of program activation. Whenever a file has not yet been saved after edit completion, its contents can be reverted back to the previous settings.

Select [File] → [Reopen file].

6.11. Downloading the Operation Logs

Download all NX-100's operation logs programmed into the system and save them to a specified location*.

* The data folder is located in the installation folder (Default path: C:\Program Files\TOA\NX-100) of the setup program. The save location cannot be manually designated.

Select [File] → [Log file download].

6.12. Uploading Unit Setting Files

Upload the currently opened setting file to the NX-100.

Step 1. Click on the toolbar Save button or select [File] → [Save to file].
The setting file will be saved.

Step 2. Click on the Upload button or select [Setting] → [Upload].

Note

Setting file upload takes some time. Take care to never switch off the unit's power during the upload. (The Status indicator on the NX-100's front panel flashes during the upload.)

6.13. Downloading Unit Setting Files

Read the currently-connected NX-100s' setting contents into the System Setting Tool.

Click on the Download button or select [Setting] → [Download].

Programmed setting data of the units connected to the system will be displayed.

6.14. Updating Firmware

Installation Setting Program only

Update the firmware of all NX-100 units programmed into the system.

Step 1. Select [Setting] → [Firmware update].

Step 2. Select firmware file.
Firmware will be written into all connected NX-100 units.

Note

Take care to never turn off or reset the unit's power during firmware update. (The Status indicator on the unit's front panel flashes during the update.)

[Update information]

- The latest versions of the following software and manuals are open to the public on the Toa's download site <http://www.toa-products.com/international/>: NX-100 firmware, NX-100 software (Setup program and Operation program), and Instruction manuals (Installation setup manual and Operations manual). Please download them from the above web site.
- The version of each instruction manual is in the lower right corner on the last page expressed in a year-month format. Example: "200304" represents 2003, April.

7. CHANGING THE SYSTEM NAME AND PASSWORD

Step 1. In the Installation Setting Program, click on [Password Change] on the initial screen.
In the Management Setting Program, select [Help] → [Version data], and a dialog will then be displayed. Click on the Change password button.
The Password Change screen will be displayed.

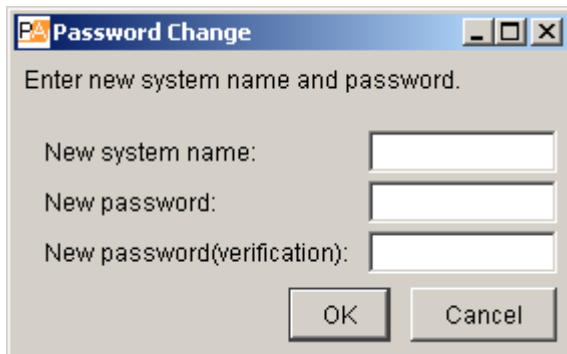

Step 2. Enter a new system name and password.
Use up to 15 alphanumeric characters to enter the system name and password. (They can be set to blank.)
Enter the password a second time for verification.

Chapter 4

SYSTEM SETTINGS (SETTING USING BROWSER)

1. OUTLINE OF SETTING USING BROWSER

Settings can also be changed without requiring installation of the dedicated NX-100 software by individually connecting to each NX-100 using the browser*.

For NX-100 units connected by way of the NAT function, such as an access via internet, perform settings from the browser. There are two operation setting modes: Installation and Management.

Installation Setting: Permits settings of all items, including network and Broadcast Spec.

Management Setting: Used to change already set contents while the system is in use.

* Browsers that ensure correct NX-100 operation:

Microsoft Internet Explorer 6, Internet Explorer 5.5, and Netscape 7

Notes

- Settings cannot be performed if the network is not correctly set. In particular, new units shipped from the factory may have duplicate default IP addresses or settings that assume the NX-100 is not connected to the same network as the PC.
- Complete network settings beforehand using the NX-100 Installation Setting program. If performing setup by the browser, disconnect the unit from the network and connect it directly to the PC's LAN port using a cross cable.
- Should the power be switched off during setting changes, the unit may be damaged.
- Changed settings are enabled after the NX-100 is restarted. Be sure to restart the unit whenever settings are changed. Broadcasts are stopped during unit restart.

2. SETTINGS

Step 1. Start up the browser and enter the URL.

Note

The factory-preset IP address is "192.168.1.1" and web server port No. is "80." When the web server port No. is "80," the description of the port number that follows the colon [:] can be omitted.

Operation Mode	URL	Example
Management setting	http://<IP address>:<Web server port No.>/index-e.htm	http://192.168.1.1/index-e.htm
Installation setting	http://<IP address>:<Web server port No.>/admin-e.htm	http://192.168.1.1/admin-e.htm

The User Authentication dialog will be displayed. (Note that the dialog display may differ depending on the browser used.)



Step 2. Enter a user name and password, then press the OK button.

Notes

- For the User name, enter the system name preset as default or by change.
- Both the user name and password are case-sensitive.

The default system name is factory-preset to "NX-100" and the password to "guest."
To change them, refer to [p. 4-28](#).

The setting menu window will be displayed if the user name and password are correctly entered.

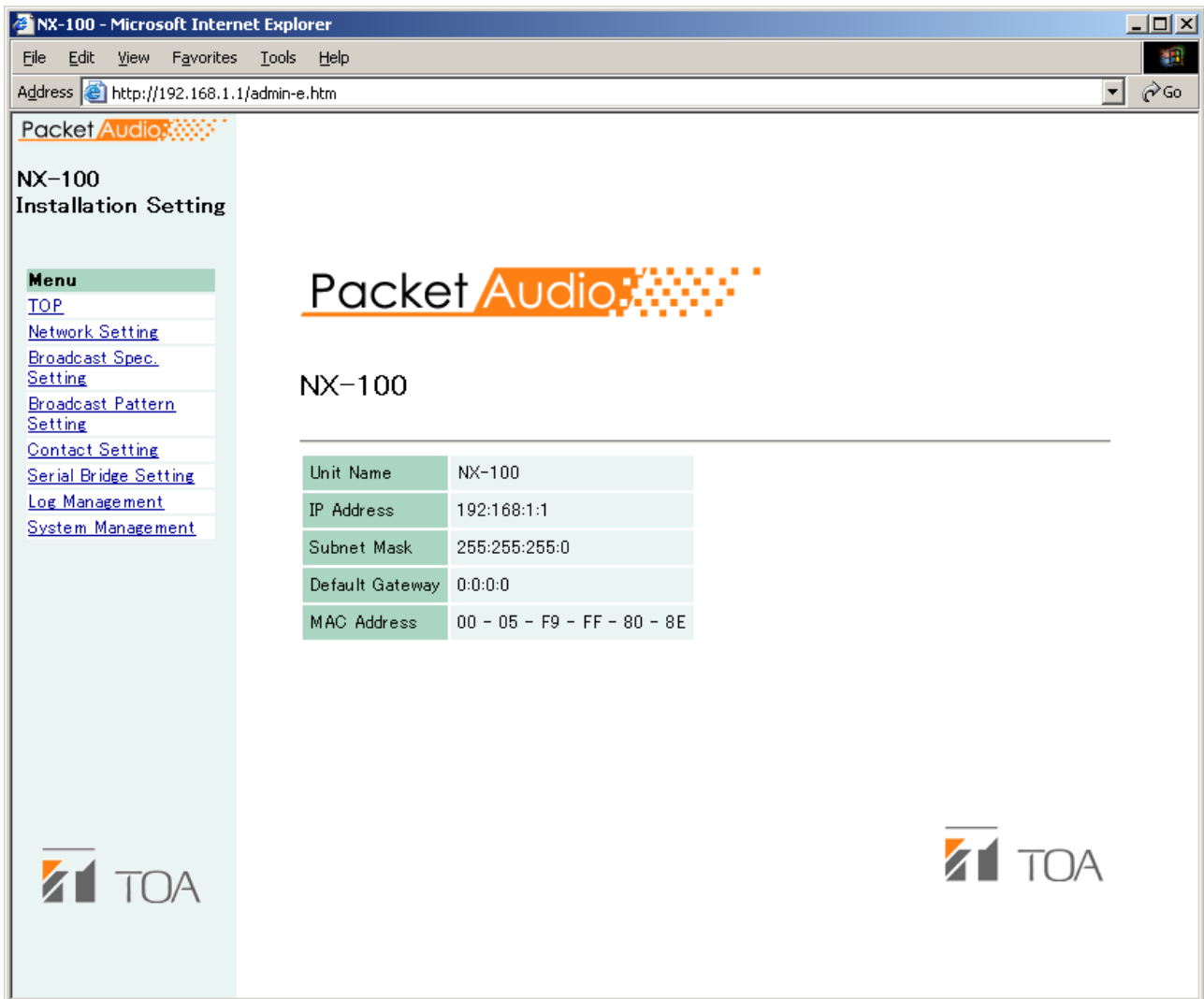

Step 3. Set each item.

Referring to the corresponding pages, perform each setting.

Caution

When displaying each browser setting screen, the screen is not correctly displayed if the Back or Forward button of the browser is used. Use the menu on the left-hand side of the window.

Menu Item	Installation Setting	Management Setting
Network setting (See p. 4-4)	✓	—
Broadcast Spec setting (See p. 4-6)	✓	—
Broadcast pattern setting (See p. 4-9)	✓	✓
Contact setting (See p. 4-13)	✓	✓
Serial bridge setting (See p. 4-18)	✓	✓
Log management (See p. 4-20)	✓	✓
System management (See p. 4-27)	✓	△*

* Only the system setting and user data can be set.

3. NETWORK SETTING

Installation Setting mode only

Set the NX-100's network.

Network Setting

IP Address: 192 . 168 . 10 . 1

Subnet Mask: 255 . 255 . 255 . 0

Default Gateway: 0 . 0 . 0 . 0

MAC Address: 00-05-F9-FF-80-8E

[TCP Port No. Assignment] [UDP Port No. Assignment]

Web server: 80 Start port no.: 5000

Start port no.: 5000

Type	Port no.	Type	Port no.
Broadcast control	5000	Stream	5000
PC control	5001	Error correction	5002
Contact bridge	5002	Resend	5004
Serial bridge	5003	Serial bridge	5006
		Sampling frequency correction	5007

Designate the port number you use in each protocol.
NOTE: Use the even number for the UDP port number.

Save

(1) IP Address

Enter the NX-100's IP address. (Factory-preset to "192.168.1.1.")

(2) Subnet Mask

Set the mask address. (Factory-preset to "255.255.255.0.")

(3) Default Gateway

Enter the gateway address if the unit is being used outside its assigned subnet.
(Factory-preset to "0.0.0.0.")

(4) Port No.

Set the start port number to be used by each protocol.
The assigned port numbers are indicated.

[TCP Port No. Assignment]

• **Web server**

Enter the web server port number
(Range: 1 – 65535; Factory-preset: 80)

• **Start port no.**

Enter the first TCP port number other than the HTTP, which is used by the NX-100.
(Range: 1 – 65532; Factory-preset: 5000)

[UDP Port No. Assignment]

Designate the first port number to be used by the UDP.

• **Start port no.**

Enter the first UDP number to be used by the unit.
(Range: EVEN numbers 1 – 65526; Factory-preset: 5000)

Caution

Since UDP port No. 15000 is used by the unit, numbers between 14990 and 15000 cannot be used.

(5) Save button

Updates the NX-100 setting file.

Caution

Never restart the unit or turn off the power during updates, or while the STATUS indicator on the front panel of the NX-100 is flashing.

4. BROADCAST SPEC SETTING

Installation Setting mode only

Set the specifications that determine broadcast streaming quality. The NX-100 starts its broadcasts based on this setting.

Packet Audio

NX-100 Installation Setting

Menu

- TOP
- Network Setting
- Broadcast Spec Setting
- Broadcast Pattern Setting
- Contact Setting
- Serial Bridge Setting
- Log Management
- System Management

Broadcast Spec Setting

Audio Setting

Sampling Frequency[kHz] Tx Rx

Compression

Network Relations

Packet Size[Byte] Tx Rx

Packet Loss Recovery

Standard

Error correction Correction level

Resend Delay time [sec]

Multicast

Yes No

Address

Sampling Frequency Correction

No (Automatic correction in the local network)

Reception (Reception of correction data from other network)

Receiving source IP Address

Receives via Multicast

Address

Transmission (Transmission of correction data to other network)

Select	IP Address	Fs Correction Port
<input type="checkbox"/>	<input type="text" value="0"/> <input type="text" value="0"/> <input type="text" value="0"/> <input type="text" value="0"/>	<input type="text" value="5007"/>
<input type="checkbox"/>	<input type="text" value="0"/> <input type="text" value="0"/> <input type="text" value="0"/> <input type="text" value="0"/>	<input type="text" value="5007"/>
<input type="checkbox"/>	<input type="text" value="0"/> <input type="text" value="0"/> <input type="text" value="0"/> <input type="text" value="0"/>	<input type="text" value="5007"/>
<input type="checkbox"/>	<input type="text" value="0"/> <input type="text" value="0"/> <input type="text" value="0"/> <input type="text" value="0"/>	<input type="text" value="5007"/>

Navigator
(Sets recommended values.)

1. Select the bandwidth a single stream can use.

2. Select the type of line you use.

Dedicated line or LAN

Internet

Information

Delay	Bandwidth
Tx <input type="text" value="0.04"/> [sec]	<input type="text" value="196"/> [kbps]
Rx <input type="text" value="0.04"/> [sec]	<input type="text" value="196"/> [kbps]

[Broadcasts possible with this spec]

Transmission only	<input type="text" value="OK"/>
Reception only	<input type="text" value="OK"/>
Local broadcast	<input type="text" value="NG"/>
Multiple unicast streaming	<input type="text" value="NG"/>
Two ways	<input type="text" value="NG"/>

TOA

(1) Navigator

Select the usable bandwidth and type of line, and press the Set button. A recommended values will then be set. If no problems are foreseen, perform the setting as is, without changing these values.

Note

Be sure to consult with network management personnel regarding bandwidth, type of line, and multicast streaming.

(2) Information

Indicates the delay time, bandwidth, and whether or not broadcasts are possible when broadcasts are made using values selected in the Broadcast Spec settings.

[Delay]

The delay time is the duration until an audio signal received at the NX-100 passes through the network and is broadcast by other connected NX-100 units.

[Bandwidth]

Indicates the bandwidth for voice streaming over the network. The bandwidth used is indicated in red if the setting exceeds the usable bandwidth set in the Navigator section.

[Broadcasts possible with this spec]

Broadcasts that are possible with the set Spec are marked with "OK", and those that are not possible are marked with "NG." The conditions under which broadcasts can be made are as follows:

Transmission only (broadcasts from the original unit to other units):

Broadcast signals can be sent to a connected unit if the transmission bandwidth is within the set bandwidth.

Reception only (broadcasts from other units to the original unit):

Broadcast signals can be received from a connected unit if the reception bandwidth is within the set bandwidth.

Local broadcast (transmissions from the original unit's audio input to its audio output):

Local broadcasts cannot be made if the transmission sampling frequency is set to 32 kHz.

Multiple unicast streaming and Two-way:

Cannot be performed when packet transmission intervals are short. Adjust the sampling frequency, compression, packet size, packet loss recovery and its level.

(3) Audio Setting

[Sampling Frequency]

Select the transmission and reception sampling frequencies from [8], [16], and [32] kHz. Sound quality improves with higher sampling frequencies, however this makes the bandwidth wider.

[Compression]

Select [Yes] or [No]. To narrow the bandwidth of the network, it is highly recommended that compression be enabled.

(4) Network Relations**[Packet Size]**

Select the size of audio packet.

The packet size cannot be changed when [Resend] is selected in Packet Loss Recovery item. Smaller packet sizes result in a wider bandwidth, however delay times become shorter.

[Packet Loss Recovery]

Select one of three recovery methods used when an audio packet is lost: [Standard], [Error Correction], and [Resend]. Refer to p. 6-4 for details of each recovery method.

In case [Error correction] is selected, the correction level can be changed, allowing selection from [1 (Low)], [2], [3], and [4 (High)]. Higher settings increase correction capability, however delay times are also made longer.

In case [Resend] is selected, delay times can be entered for 5 – 30 seconds. Longer delay times increase correction capability. Note that [Resend] cannot be selected if [Compression] is set to "No."

[Multicast]

The multicast address must be set when sending multicast streaming. Selecting "Yes" for Multicast allows the multicast address to be entered. The effective address range is from (225.0.0.0) to (238.255.255.255). Perform this setting while taking care that the same number is not duplicated among the units connected to the same network.

Note

Be sure to consult with network management personnel before performing this setting.

(5) Sampling Frequency Correction

Refer to p. 6-4 for sampling frequency correction.

[Transfer Setting between Networks]

Perform the setting to transfer sampling frequency correction data between different networks. (Correction data within the LAN* are automatically transmitted and received.)

* Broadcast effective range

No: Corrects correction data only in the LAN, without transferring data to other networks.

Reception: Receives correction data from other networks. Enter the receiving source IP address in the corresponding box that is ready for entry. When receiving correction data via Multicast, tick the checkbox of "Receives via Multicast." and enter the Multicast IP address to be used.

Transmission: Transmits correction data to other networks. Since the data input boxes for the target transmission unit become ready for entry, enter both the IP address and port number of the target unit.

(6) Save button

Updates the NX-100 setting file.

Caution

Never restart the unit or turn off the power during updates, or while the STATUS indicator on the front panel of the NX-100 is flashing.

5. BROADCAST PATTERN SETTING

The broadcast pattern is determined by the combination of broadcast direction and the units targeted to receive or transmit the broadcast, and is set in the unit that initiates the broadcast. The pattern then starts the broadcast when a contact or program operation input is received. Local broadcasts which do not use the network or single stream broadcasts can also be set as broadcast patterns. (Target receiving unit: 1; Target unicast transmission unit: 1; Target multicast transmission units: 64)

Create a new broadcast pattern by clicking on the Pattern Addition button, or select and edit a pattern which has already been programmed.

Packet Audio

NX-100 Installation Setting

Menu

- [TOP](#)
- [Network Setting](#)
- [Broadcast Spec Setting](#)
- [Broadcast Pattern Setting](#)
- [Contact Setting](#)
- [Serial Bridge Setting](#)
- [Log Management](#)
- [System Management](#)

Broadcast Pattern Setting

Programmed Pattern List

Pattern Selection	Broadcast Pattern Name	Enable Broadcast
<input type="radio"/>	Hall 1	OK
<input type="radio"/>	Hall 2	OK
<input type="radio"/>	Hall 3	OK
<input type="radio"/>	Parking	OK
<input type="radio"/>	All	OK

Pattern Edit Pattern Addition Pattern Deletion

Addition of Pattern

Name:

Direction: Local broadcasts not possible with this Spec setting.

Target Unit List
No unit listed.
(Program by entering in the target unit addition frame and pressing the Target Unit Addition button.)

Target Unit Addition
Add to the above [Target unit list].
Target Unit: . . . Broadcast control port: (TCP)
Target Unit Addition

Audio Stream Target Port
 (UDP)

Save

When you press the Save button, the above settings are programmed into the unit, and added to the Programmed Pattern List. (Settings not changed by merely editing the pattern.)

5.1. Pattern Selection Area

(1) Programmed Pattern List

Displays a list of the unit's programmed patterns, and whether or not broadcasts are possible. Patterns which cannot be broadcast due to the Broadcast Spec settings are highlighted in red with an "NG" displayed in the corresponding "Enable Broadcast" column. Disabled broadcasts are usually caused by incorrect multicast or transmission sampling frequency settings (for instance, local broadcasts cannot be made at 32 kHz). Be sure to review the Broadcast Spec settings.

[Pattern Selection]

Select the pattern to edit or delete.

After selection, press the Pattern Edit button to edit, and the Pattern Deletion button to delete.

(2) Pattern Edit button

Displays the selected broadcast pattern in the pattern edit area.

The "Pattern Edit" title is displayed in the edit area.

Pressing the Save button after edit updates the pattern setting.

(3) Pattern Addition button

Adds a new broadcast pattern. The "Addition of Pattern" title is displayed in the pattern edit area. Pressing the Save button after edit adds the pattern. The new pattern is added to the programmed pattern list and displayed in the pattern selection area.

(4) Pattern Deletion button

Deletes the selected broadcast pattern and updates the NX-100 setting file.

Caution

Never restart the unit or turn off the power during updates, or while the STATUS indicator on the front panel of the NX-100 is flashing.

5.2. Pattern Edit Area

The pattern addition display differs from the pattern editing display for the selected pattern. (The "Addition of Pattern" screen is displayed by default when no pattern is selected.)

5.2.1. Pattern addition

"Addition of Pattern" is displayed as the pattern edit area's title when no pattern is selected or when the Pattern Addition button is pressed.

(1) Name

Enter the pattern name to be programmed into the NX-100.

"New Pattern" is displayed when the Pattern Addition button is pressed. Change this indication to the appropriate pattern name.

Caution

Take care not to assign a pattern name which is already programmed.

(2) Direction

Select the broadcast direction.

Transmission: Broadcasts from the original unit to other units.

Reception: Broadcasts from other units to the original unit.

Local: Broadcasts from the original unit's audio input to its own audio output.

Caution

"Local" cannot be selected when the transmission sampling frequency is set to [32 kHz] in the Broadcast Spec setting.

(3) Target Unit

The IP addresses of the target NX-100 units are displayed.

When "Transmission" is selected in the Direction setting, broadcasts are sent all added NX-100 target units. When "Reception" is selected, broadcasts are received from the added target NX-100 unit. Target units cannot be added when "Local" has been selected.

[Target Unit Addition]

The combination of the broadcast direction and target unit that enables single stream broadcasts can be set as the broadcast pattern. The number of target units that can be added is 1 unit for reception, and 64 units for transmission when multicast streaming is possible or 1 unit for transmission when multicast streaming is not possible.

Enter the IP address and transmission control port for each target unit, then press the Target Unit Addition button. The set target unit will be added to the Target Unit list.

(Example of addition to the Target Unit list)

Target Unit List		
IP address	Broadcast control port	Target Unit Deletion
192.168.1.2	5000	<input type="checkbox"/>
192.168.1.3	5000	<input type="checkbox"/>

Caution

Units are not added by merely entering them in the Target Unit Addition frame. Be sure to confirm that the unit is added to the list after the Target Unit Addition button is pressed, and then press the Save button. The Target Unit Addition button is automatically disabled when target units can no longer be added.

[Target Unit Deletion button]

Pressing the Target Unit Deletion button after selecting a target unit in the Target Unit List will delete the selected unit from the list. Multiple target units can also be selected for deletion.

(4) Audio Stream Target Port

Enter the port number of the target unit to be used by the audio stream.

(5) Save button

Updates the NX-100 setting file.

When adding a pattern, the unit's name appears in the Programmed Pattern List.

Note

The broadcast control port number and audio stream target port are displayed in the "Network Setting" screen for the target unit. (Refer to [p. 4-4, NETWORK SETTING.](#))

Caution

Never restart the unit or turn off the power during updates, or while the STATUS indicator on the front panel of the NX-100 is flashing.

5.2.2. Pattern editing

When the Pattern Edit button is pressed while a programmed broadcast pattern is selected in the pattern selection area, the Edit of Pattern title and the name of the pattern before being changed are displayed. The setting contents of the pattern are also displayed in the pattern edit area for editing.

PacketAudio

NX-100 Installation Setting

Menu

- [TOP](#)
- [Network Setting](#)
- [Broadcast Spec Setting](#)
- [Broadcast Pattern Setting](#)
- [Contact Setting](#)
- [Serial Bridge Setting](#)
- [Log Management](#)
- [System Management](#)

Broadcast Pattern Setting

Programmed Pattern List

Pattern Selection	Broadcast Pattern Name	Enable Broadcast
<input checked="" type="radio"/>	Hall 1	OK
<input type="radio"/>	Hall 2	OK
<input type="radio"/>	Hall 3	OK
<input type="radio"/>	Parking	OK
<input type="radio"/>	All	OK

Pattern Edit Pattern Addition Pattern Deletion

Edit of Pattern (Name before change: Hall 1)

Name:

Direction: Local broadcasts not possible with this Spec setting.

Target Unit List

IP address	Broadcast control port	Target Unit Deletion
192.168.10.2	5000	<input type="checkbox"/>
192.168.10.3	5000	<input type="checkbox"/>

Target Unit

Target Unit Addition
Add to the above [Target unit list].

. . . Broadcast control port (TCP)

Target Unit Addition

Audio Stream Target Port
 (UDP)

Save

When you press the Save button, the above settings are programmed into the unit, and added to the Programmed Pattern List.
(Settings not changed by merely editing the pattern.)

TOA

Press the Save button to program the edited pattern. Pressing the Save button will update the NX-100's setting file.

Caution

Never restart the unit or turn off the power during updates, or while the STATUS indicator on the front panel of the NX-100 is flashing.

6. CONTACT SETTING

When the NX-100's contact input is activated, its set broadcast pattern starts broadcasting while simultaneously enabling other NX-100 contact outputs. Here, contact input and output settings are performed.

Contact Setting

Input 1 2 3 4 5 6 7 8

Output 1 2 3 4 5 6 7 8

- Input CHI -

Enable Disable

Operation Mode:

Polarity:

Broadcast Pattern

Select	Pattern name	Direction	Enable	Bandwidth
<input type="checkbox"/>	Hall 1	Transmission (Multicast)	YES	130 kbps
<input type="checkbox"/>	Hall 2	Transmission (Multicast)	YES	
<input type="checkbox"/>	Hall 3	Transmission (Multicast)	YES	
<input type="checkbox"/>	Parking	Transmission (Unicast)	YES	
<input checked="" type="checkbox"/>	All	Transmission (Multicast)	YES	

Programmed Target Output

IP address	Port no.	Channel								Delete
		1	2	3	4	5	6	7	8	
192.168.10.2	5002	<input checked="" type="checkbox"/>	<input type="checkbox"/>	<input type="checkbox"/>	<input type="checkbox"/>	<input type="checkbox"/>	<input type="checkbox"/>	<input type="checkbox"/>	<input type="checkbox"/>	<input type="checkbox"/>
192.168.10.3	5002	<input checked="" type="checkbox"/>	<input type="checkbox"/>	<input type="checkbox"/>	<input type="checkbox"/>	<input type="checkbox"/>	<input type="checkbox"/>	<input type="checkbox"/>	<input type="checkbox"/>	<input type="checkbox"/>
192.168.10.4	5002	<input checked="" type="checkbox"/>	<input type="checkbox"/>	<input type="checkbox"/>	<input type="checkbox"/>	<input type="checkbox"/>	<input type="checkbox"/>	<input type="checkbox"/>	<input type="checkbox"/>	<input type="checkbox"/>
192.168.10.5	5002	<input checked="" type="checkbox"/>	<input type="checkbox"/>	<input type="checkbox"/>	<input type="checkbox"/>	<input type="checkbox"/>	<input type="checkbox"/>	<input type="checkbox"/>	<input type="checkbox"/>	<input type="checkbox"/>
192.168.10.6	5002	<input checked="" type="checkbox"/>	<input type="checkbox"/>	<input type="checkbox"/>	<input type="checkbox"/>	<input type="checkbox"/>	<input type="checkbox"/>	<input type="checkbox"/>	<input type="checkbox"/>	<input type="checkbox"/>
192.168.10.7	5002	<input checked="" type="checkbox"/>	<input type="checkbox"/>	<input type="checkbox"/>	<input type="checkbox"/>	<input type="checkbox"/>	<input type="checkbox"/>	<input type="checkbox"/>	<input type="checkbox"/>	<input type="checkbox"/>
192.168.10.8	5002	<input checked="" type="checkbox"/>	<input type="checkbox"/>	<input type="checkbox"/>	<input type="checkbox"/>	<input type="checkbox"/>	<input type="checkbox"/>	<input type="checkbox"/>	<input type="checkbox"/>	<input type="checkbox"/>

New Connect Point

IP address	Port no.	Channel							
		1	2	3	4	5	6	7	8
<input type="text" value=""/>	<input type="text" value="5002"/>	<input type="checkbox"/>	<input type="checkbox"/>	<input type="checkbox"/>	<input type="checkbox"/>	<input type="checkbox"/>	<input type="checkbox"/>	<input type="checkbox"/>	<input type="checkbox"/>

(1) Contact Selection

Select the contact to be set. Selecting the input or output channel number of the contact displays its contact's setting contents.

(2) Enable/Disable Selection

Select "Enable" or "Disable" for the contact.

Select "Enable" when using the contact function. All setting items are then ready for entry.

6.1. Contact Input Setting

Set the broadcast pattern to be started, and the contact bridge. When the contact input is selected, the screen will switch over to the contact input setting screen. Select [Enable] and set the contact input contents.

(1) Operation Mode

Select from [Momentary] and [Latch]. Operations are as follows:

Momentary: The designated broadcast pattern or other unit's contact is activated while the input is ON. The start mode stops when the input is OFF.

Latch: When the input is turned on, the designated broadcast pattern or other unit's contact is activated, and the start mode continues even if the input is turned OFF. The start mode stops when the input is turned ON again.

• Momentary

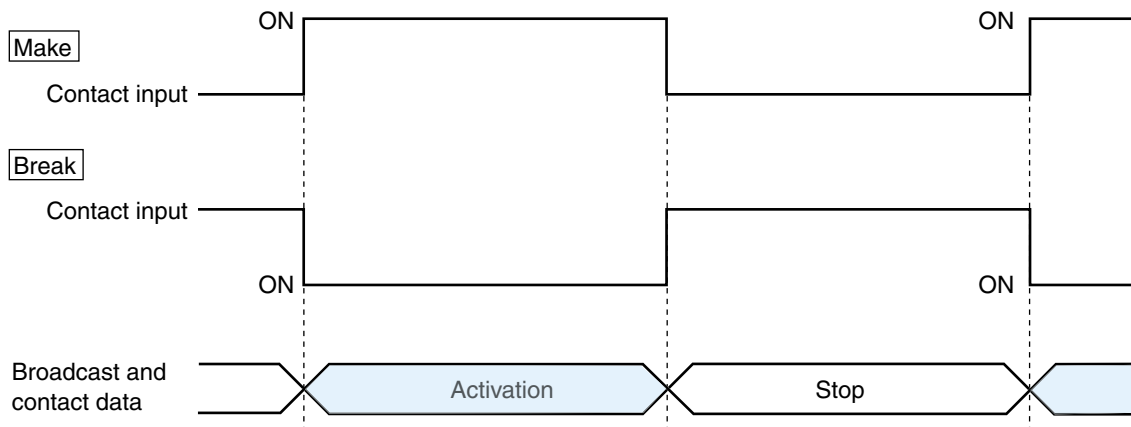

• Latch

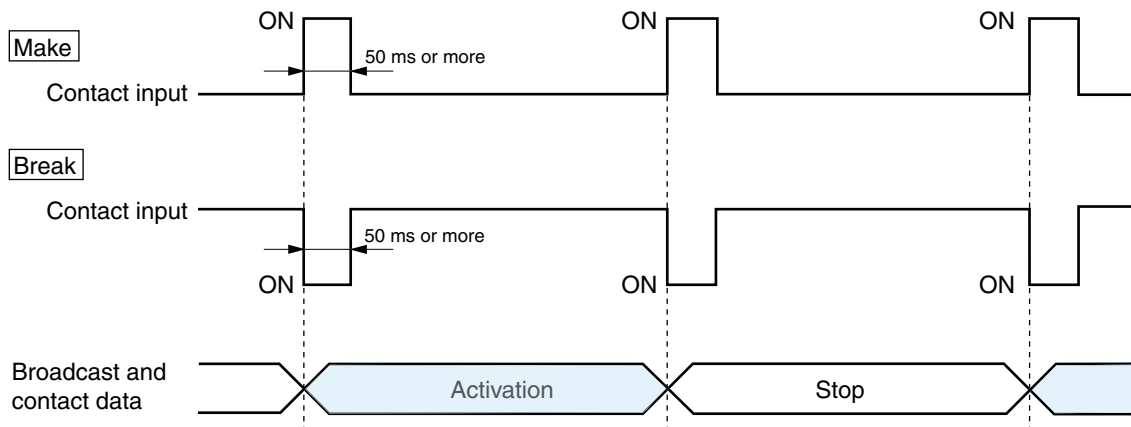

(2) Polarity

Set to either [Make] or [Break].

Make: ON when contact is closed.

Break: ON when contact is opened.

(3) Broadcast Pattern

The NX-100's list of programmed broadcast patterns is displayed. Select the pattern to be started. Patterns which cannot be broadcast due to the Broadcast Spec settings are highlighted in red with a "NO" displayed in the corresponding "Enable" column. Disabled broadcasts are usually caused by incorrect multicast or transmission sampling frequency settings (for instance, local broadcasts cannot be made at 32 kHz).

[Select]

Select the pattern to be started. When cancelling the selection, click on the same checkbox again to remove the tick.

[Pattern name]

Displays the programmed broadcast pattern name.

[Direction]

Displays the type of broadcasting.

Transmission (Multicast): Transmits a single stream broadcast to multiple units. Multicast must be set to "Yes" in the Broadcast Spec Setting.

Transmission (Unicast): Transmits a single stream broadcast to a single unit.

Reception: Receives broadcasts from the target unit.

Local: Broadcast from the original unit's input to its own output.

[Enable]

Indicates whether or not the programmed broadcast pattern can be broadcast. If "NO" is displayed for a pattern, review the Broadcast Spec settings.

[Bandwidth]

Indicates the total bandwidth used by the set pattern.

Caution

Broadcasts cannot be made if the setting exceeds the available bandwidth.

(4) Contact Bridge

The Contact Bridge refers to the function that enables the contact outputs of other connected NX-100 or original NX-100 when the original unit's contact input is activated. Here, select NX-100 contact outputs to be activated when the original unit's contact input is activated.

[Programmed Target Output]

Tick on the appropriate boxes when wishing to change only the programmed target unit's contact output channel. Tick the corresponding rightmost checkbox to select programmed target units to be deleted, then click on the Delete button to remove from the list.

[New Connect Point]

When performing initial programming, enter the new target unit's IP address, contact control port number and select the channel number, then click on the Add button.

Entering the original unit's IP address and port number as a new connecting point permits the original unit's contact output to be activated.

(5) Save button

Updates the NX-100 setting file.

Caution

Never restart the unit or turn off the power during updates, or while the STATUS indicator on the front panel of the NX-100 is flashing.

6.2. Contact Output Setting

Set the contact output to be activated when the NX-100 is enabled by other unit or the operation program. Selecting a contact output will switch the display to the contact output setting screen. Select "Enable" and set the contact output contents.

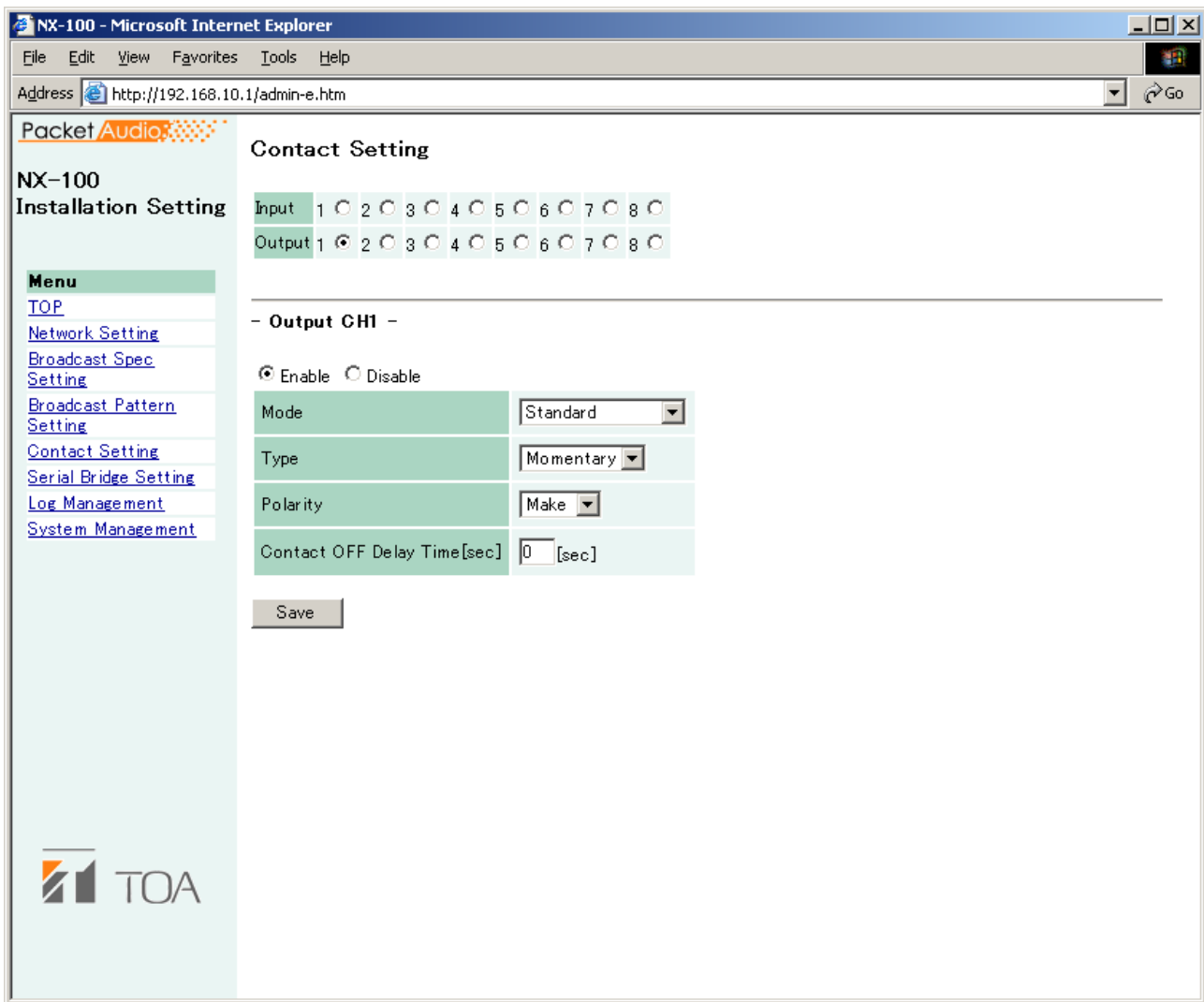

(1) Mode

Select Mode from [Standard], [STATUS Output], and [ERROR Output].

Standard: Provides output by way of control from a PC or contact inputs of other units or original unit.

STATUS Output: Provides output synchronizing with the STATUS indicator operation.

ERROR Output: Provides output synchronizing with the ERROR indicator operation.

Note

To use the Contact bridge function, select [Standard].

(2) Type

Select from [Momentary] and [Latch].

Momentary: Provides output during the period between receiving an activation request and receiving a stop request.

Latch: Provides 1 second of output upon receiving an activation request and 1 second of output upon receiving a stop request.

Note

[Latch] cannot be selected when setting Mode to [STATUS Output] or [ERROR Output].

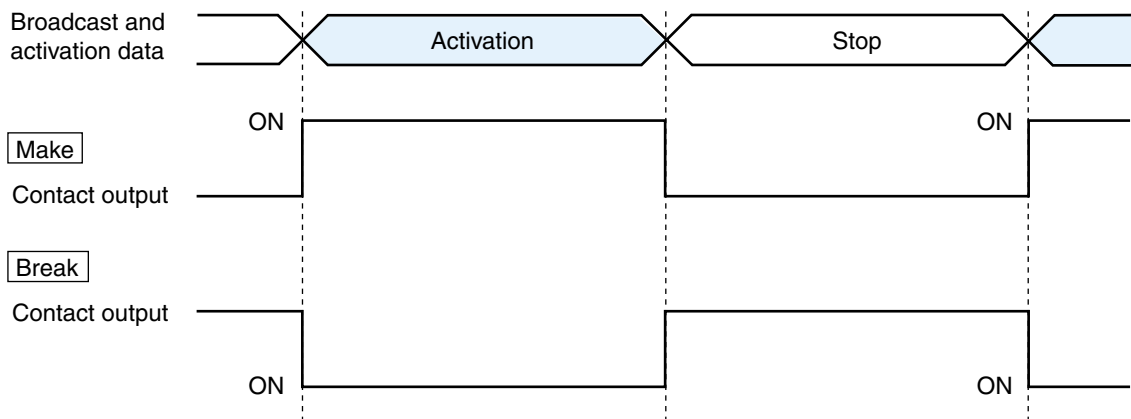
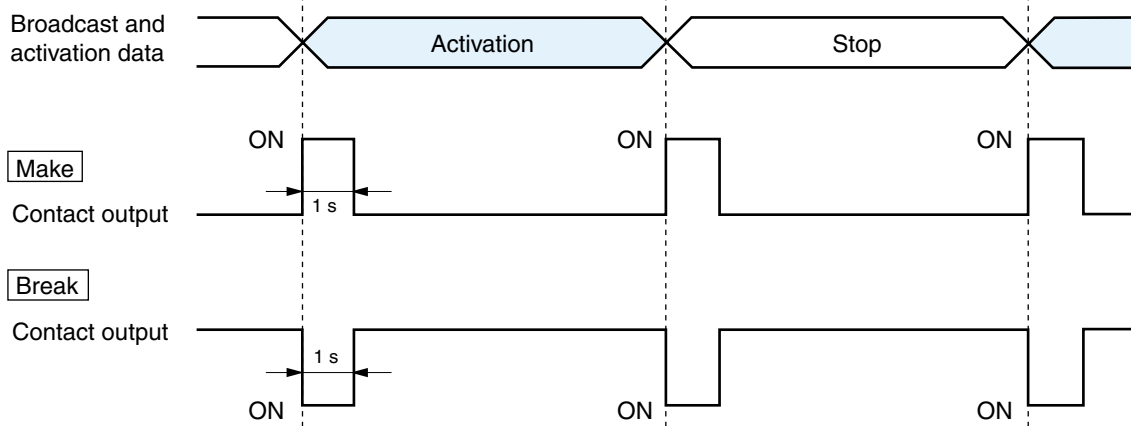
• Momentary**• Latch****Caution**

The unit's correct operation cannot be ensured if both activation and stop signals are received during the 1-second output interval.

(3) Polarity

Select Polarity from [Make] and [Break].

Make: ON when the contact is closed.

Break: ON when the contact is opened.

(4) Contact OFF Delay Time [sec]

Enter an OFF delay time of 0 – 60 seconds for the duration between receiving a termination request and actually turning OFF the contact. When in Resend mode and making broadcasts with longer delay times, set the OFF delay time to correspond to the delay time.

Note

For more information regarding OFF delay times, refer to [p.6-4](#).

(5) Save button

Updates the NX-100 setting file.

Caution

Never restart the unit or turn off the power during updates, or while the STATUS indicator on the front panel of the NX-100 is flashing.

7. SERIAL BRIDGE SETTING

Perform serial bridge settings.

(1) Enable/Disable Selection

Select "Enable" when using this function. All items can be ready for entry.

(2) Network Setting

[Protocol]

Select the serial bridge communication configuration.

TCP Server: The original unit carries out communications as a TCP server. The NX-100 unit connected to this server must be set as a TCP client in its protocol settings.

TCP Client: The original unit carries out communications as a TCP client. The target NX-100 unit must be set as a TCP server in its protocol settings.

UDP: Carries out communications using UDP. The target NX-100 unit's protocol settings must be set to UDP.

[Target Unit's IP Address]

Enter the target unit's IP address and port number.

Note

Enter the global IP address if using the Internet.

(3) Serial Port Setting

[Baud Rate]

Select [9600], [19200], [38400], [57600], or [115200]

[Data Length (bit)]

Select to [7 bits] or [8 bits].

[Parity]

Select [Even], [Odd], or [None].

[Stop Bit]

Select [1 bit] or [2 bits].

[Flow Control]

Select the type of flow control.

None: Flow control is not performed.

Xon/Xoff: Performs software flow control.

Hardware: Performs hardware flow control.

(4) Other

[Automatic Cutoff Time (minutes)]

Set the time interval (timeout duration: 0 – 60 minutes) before the connected unit is automatically disconnected following the end of the last communication. The connected unit is not disconnected if the timeout duration is set to [0]. This function is only available for TCP connections.

[Transmit/Receive RAW data.]

Tick the checkbox when transmitting and receiving raw data. Data with control information to be utilized between NX-100 units is usually transmitted, but raw data communications are generally carried out without such control information. However, when communications with other connected units are cut off, this cannot be detected. Raw data communications are only possible while in TCP connection mode.

(5) Save button

Updates the NX-100 setting file.

Caution

Never restart the unit or turn off the power during updates, or while the STATUS indicator on the front panel of the NX-100 is flashing.

8. LOG MANAGEMENT

The unit's operation logs are displayed and saved.

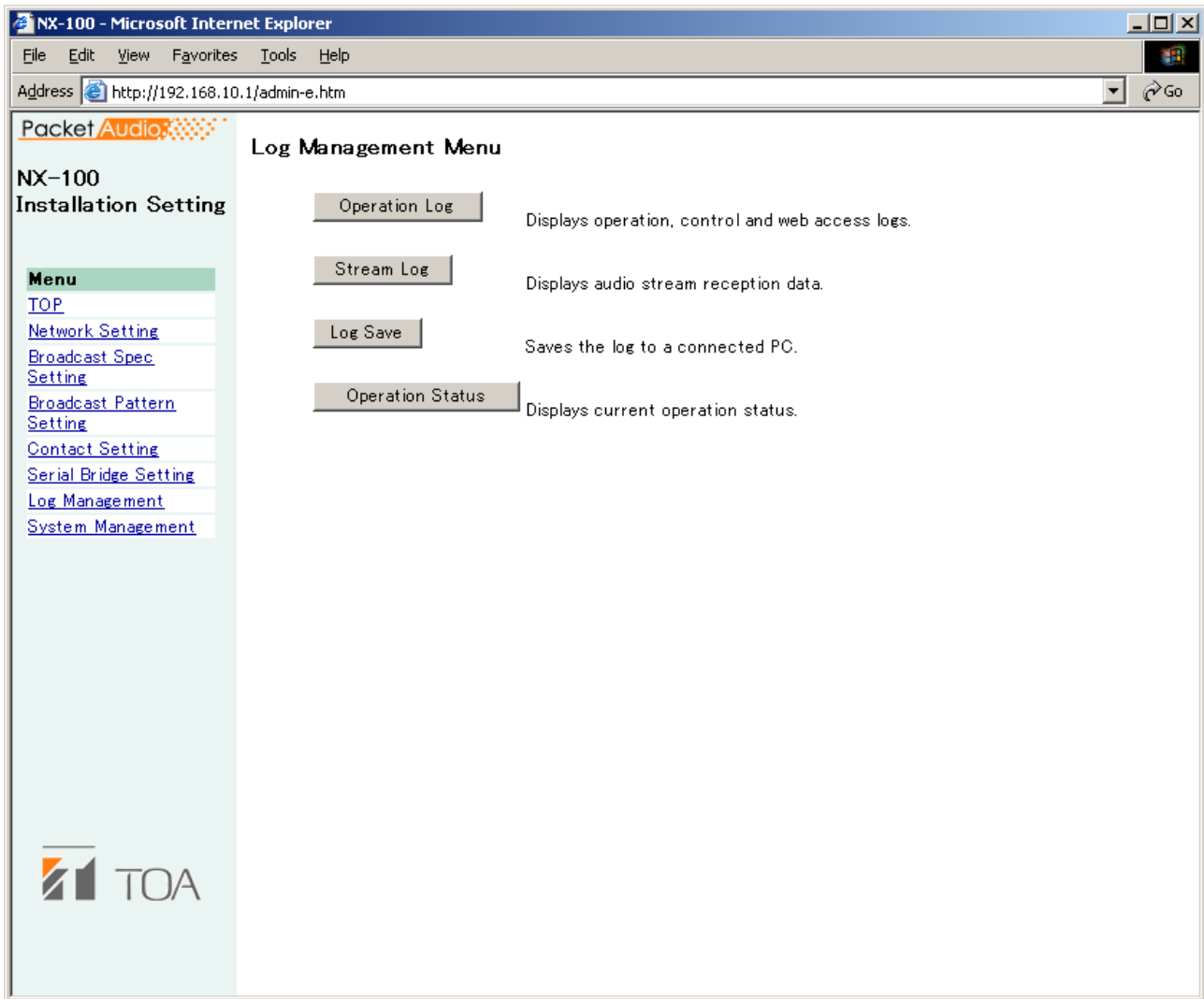

- (1) **Operation Log button**
Displays the NX-100's operation log.
- (2) **Stream Log button**
Displays streaming reception log.
- (3) **Log Save button**
Saves log as a file in the PC.
- (4) **Operation Status button**
Displays the NX-100's current operation status.

8.1. Operation Log

The operation log screen is displayed when the Operation Log button is pressed on the Log Management Menu screen.

Operation Log
Dec/12/2002 10:19:27

Latest Prev. Page Next Page Clear Display Change

Display Change: Displays or hides the web access log.
page 1

Time	Category	Requesting Source	Contents
Dec/12/2002 10:18:45	WEB	192.168.10.91	/act_log_e.cgi
Dec/12/2002 10:18:42	WEB	192.168.10.91	/act_log_e.cgi
Dec/12/2002 10:18:35	SWITCH	CHANNEL 1	STOP PATTERN ID=10
Dec/12/2002 10:18:35	SESSION	LOCAL	DISCONNECT 192.168.10.2 ID=10
Dec/12/2002 10:18:29	SWITCH	CHANNEL 1	START PATTERN 1 OK ID=10
Dec/12/2002 10:18:29	SESSION	LOCAL	CONNECT OK 192.168.10.2 ID=10
Dec/12/2002 10:18:17	SWITCH	CHANNEL 1	STOP PATTERN ID=9
Dec/12/2002 10:18:17	SESSION	LOCAL	DISCONNECT 192.168.10.2 ID=9
Dec/12/2002 10:18:05	SWITCH	CHANNEL 1	START PATTERN 1 OK ID=9
Dec/12/2002 10:18:05	SESSION	LOCAL	CONNECT OK 192.168.10.2 ID=9
Dec/12/2002 10:17:55	SWITCH	CHANNEL 1	STOP PATTERN ID=8
Dec/12/2002 10:17:55	SESSION	LOCAL	DISCONNECT 192.168.10.2 ID=8
Dec/12/2002 10:17:44	WEB	192.168.10.91	/act_log_e.cgi
Dec/12/2002 10:17:43	WEB	192.168.10.91	/log_e.cgi
Dec/12/2002 10:17:39	WEB	192.168.10.91	/top_e.cgi

[Operation button]

(1) Latest button

Updates the operation log to current data.

(2) Prev. Page button

Moves to the previous page.

(3) Next Page button

Moves to the next page.

(4) Clear button

Deletes all operation logs.

(5) Display Change button

Displays or hides the web access log.

[Items in the Table]

(1) Time

Indicates the time the event took place.

(2) Category

Indicates the type of log.

SESSION: Communications between units

REMOTE: Control by a PC

SWITCH: Monitoring of the contact input and the contact control

SERIAL: Serial bridge operating status

SYSTEM: System information

WEB: Web server access log

STREAM: Status of audio stream

(3) Requesting Source

Indicates the IP addresses of communication parties or requesting sources of the events such as designating contact channels.

(4) Contents

Indicates the contents of events. Levels are "Normal" (green), "Caution" (yellow), and "Error" (red).

8.2. Saving Operation Logs

Follow the procedures below to save logs to a PC:

Step 1. Press the Operation Log Save button on the Log Management Menu screen.

A dialog is displayed.

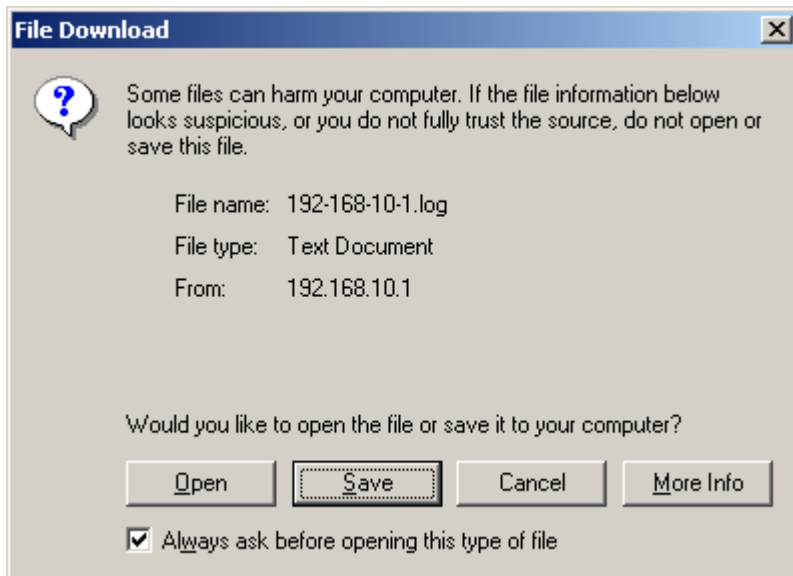

Step 2. Press the Save Button.

The screen for selecting the storage location is displayed.

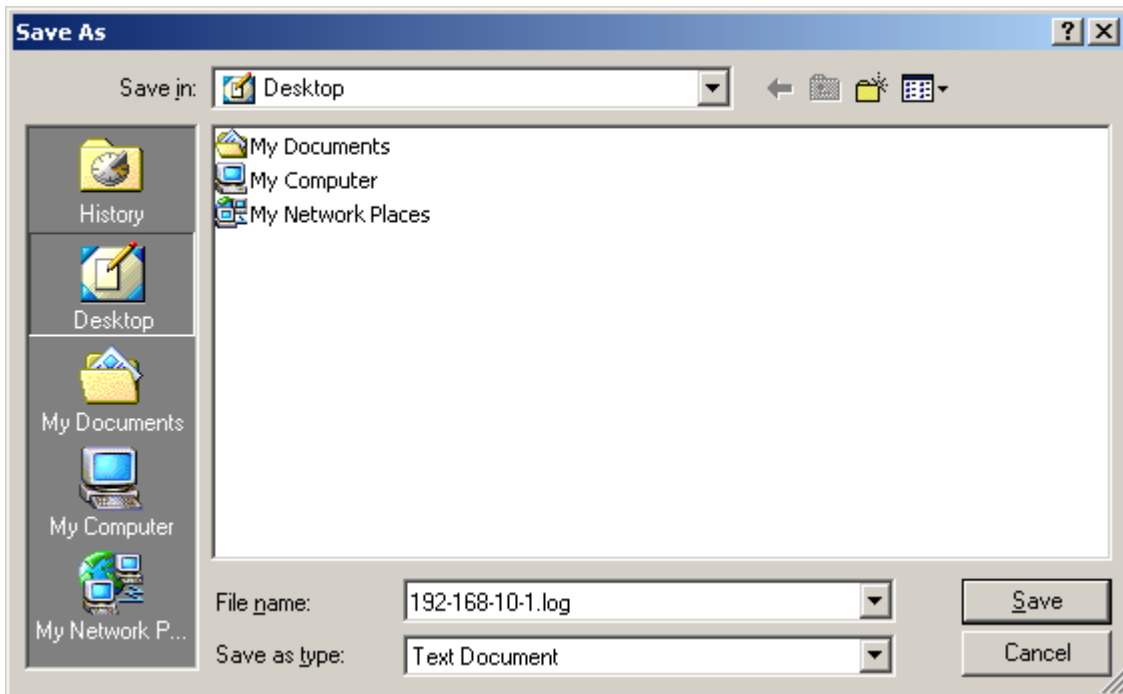

Step 3. Select the storage location and enter a filename.

Tip

The default filename is "[IP address].log."

Step 4. Select [All files] for "Save as type", then press the Save button.

8.3. Stream Logs

The Stream Log screen is displayed when the Stream Log button is pressed on the Log Management Menu screen.

Stream Log
Dec/12/2002 10:23:35

Refresh Clear

Current Stream

Stream Data	Start time	Transmitting source	Loss recovery
	Dec/12/2002 10:22:55	192.168.10.2	Standard

Reception Log	Time	Last5sec	10	15	20	25	30	Earlier	Total
Correct Reception	625	625	625	625	625	625	1057	4807	
Error	0	0	0	0	0	0	0	0	
Restoration	0	0	0	0	0	0	0	0	
Loss	0	0	0	0	0	0	0	0	
Silent tone insertion	0	0	0	0	0	0	0	0	

Past Reception Log

Time	Duration	Transmitting Source	Recovery	Reception	Error	Restoration	Loss	Silent
Dec/12/2002 10:22:15	37	192.168.10.2	Standard	4675	0	0	0	0
Dec/12/2002 10:21:59	13	192.168.10.2	Standard	1728	0	0	0	0

TOA

[Operation Button]

- (1) **Refresh button**
Updates to the most recent data.
- (2) **Clear button**
Deletes all stream reception logs.

[Items in the Table]

(1) Current Stream

- Stream Data
- Reception Log

Correct Reception: The number of packets received correctly. (The number of error packets or recovered packets is not included.)

Error: The number of packets whose packet length and header data are not matched.

Restoration: The number of packets recovered by error correction or resending, out of those that were lost due to network failures.

Loss: The number of packets not recovered, out of those lost due to network failures.

Silent tone insertion: The number of packets that caused no sound from the audio output.

(2) Past Reception Log

The network is possibly congested when the "Loss" number increases.

8.4.Operation Status

The Operation Status screen is displayed when the Operation Status button is pressed on the Log Management Menu screen.

Status monitor

Dec/12/2002 10:26:48

Broadcast

ID	Control Session	Direction	Connected Unit	Compression	fs	Loss Recovery
2	Client	Reception	192.168.10.2	Yes	16K	Standard

Contact

Channel	1	2	3	4	5	6	7	8
Input	ON	-	-	-	-	-	-	-
Output	OFF	-	-	-	-	-	-	-

Serial Bridge

Mode	Status	Target
UDP	RUN	192.168.10.6

[Operation Button]

(1) Refresh button

Updates status to the most recent data.

[Item in the Table]

(1) Broadcast

Indicates the condition of the current broadcast.

(2) Contact

Indicates the conditions (ON/OFF) of the contact input and output.

(3) Serial Bridge

Indicates the condition of serial bridge communications.

9. SYSTEM MANAGEMENT

Note

The System Management Utility area is not displayed when in Management Setting mode.

[Unit Data]

(1) Unit Name

Enter the NX-100's name.

(2) Audio Input Unit Name

Enter a name when connecting the audio input unit.

(3) Audio Output Unit Name

Enter a name when connecting the audio output unit.

(4) Unit Data Change button

Updates only system setting data in the NX-100 setting file.

Caution

Never restart the unit or turn off the power during updates, or while the STATUS indicator on the front panel of the NX-100 is flashing.

[User Data]

System names and passwords can be changed.

Step 1. Enter the new system name in the System Name frame.

Tips

- The current system name is displayed.
- Use up to 15 alphanumeric characters to enter the system name. (It can be set to blank.)

Step 2. Enter a new password in the New Password frame.

Tip

Use up to 15 alphanumeric characters to enter the password. (It can be set to blank.)

Step 3. To confirm, enter the password entered in **Step 2** in the New Password (verification) frame.
Enter the same password again for verification.

Step 4. Press the User Data Change button.

Updates only user data in the NX-100 setting file.

Caution

Never restart the unit or turn off the power during updates, or while the STATUS indicator on the front panel of the NX-100 is flashing.

[System Management Utility] Installation Setting mode only

(1) Setting File Upload

Uploads backed up setting files.

Step 1. Press the Browse button.

The Choose file dialog opens.

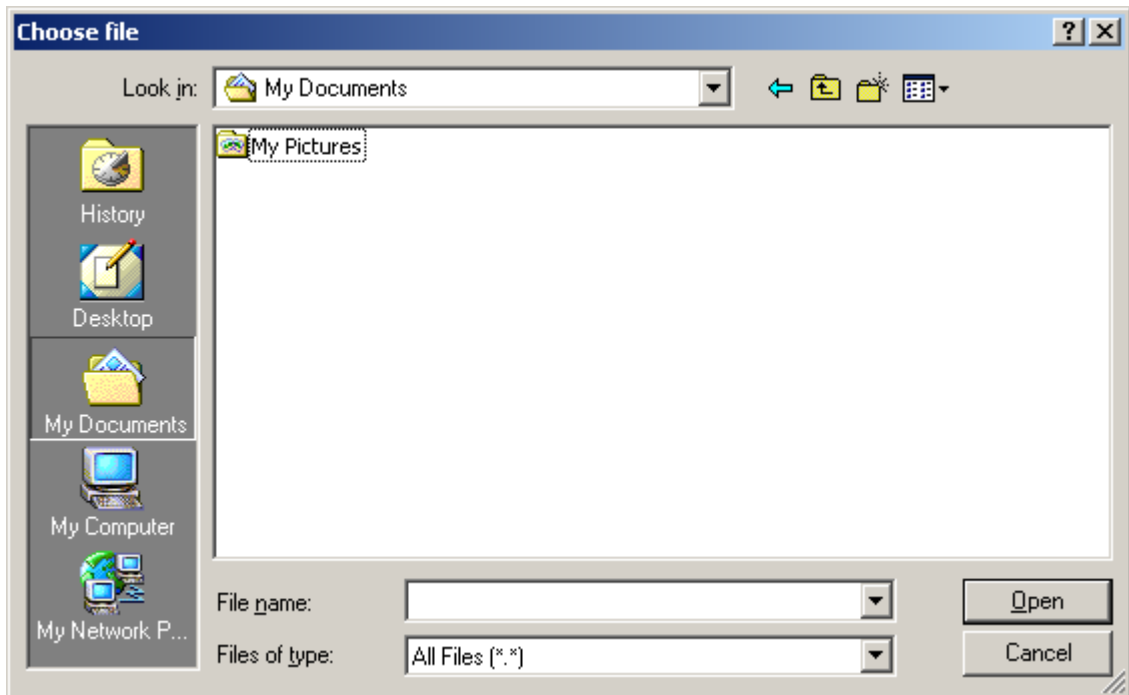

Step 2. Select the backup file (.cfg extension), then press the Upload button.

Update of the setting file begins.

Caution

Never restart the unit or turn off the power during updates, or while the STATUS indicator on the front panel of the NX-100 is flashing.

(2) Setting File Download

Backs up the setting file.

Step 1. Press the Download button.

A dialog is displayed.

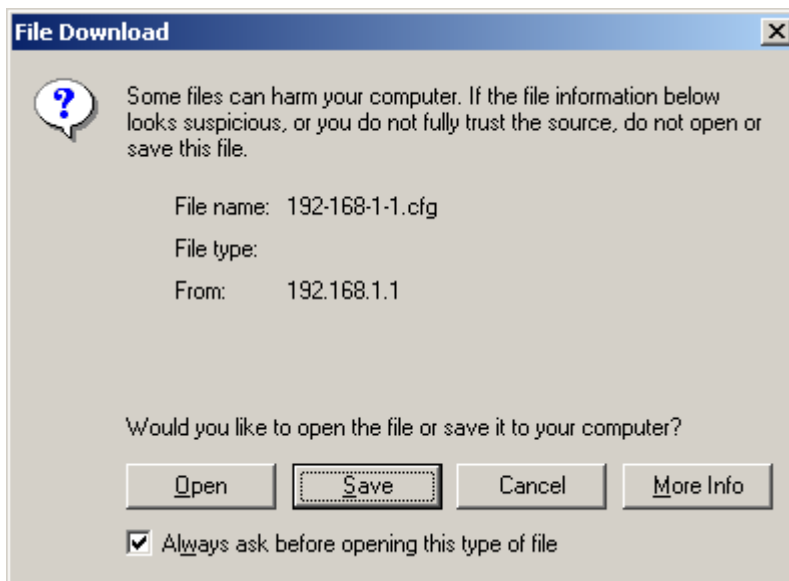

Step 2. Press the Save button.

A dialog is displayed.

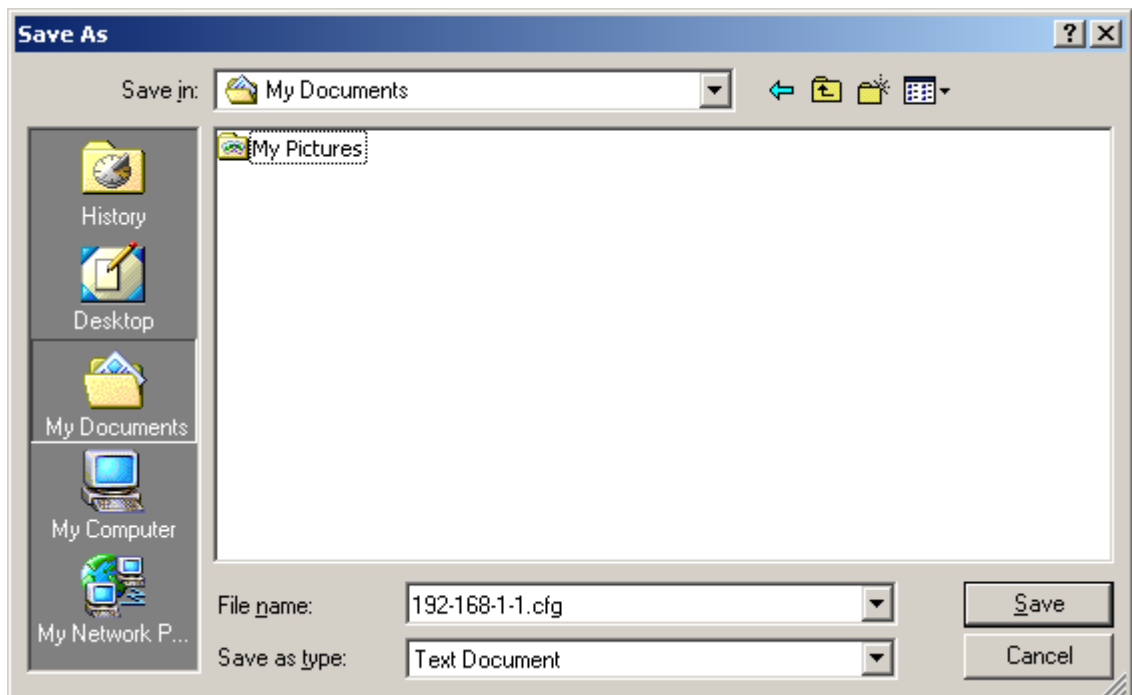

Step 3. Select the save destination and enter a filename.

Tip

The default filename "[IP address].cfg" is first displayed.

Step 4. Select [All files] for "Save as type", then press the Save button.

(3) Delete All Settings

Deletes all settings to return them to their original settings when supplied.
The unit is factory-preset as follows:

IP Address: 192.168.1.1
Unit Name: NX-100
System Name: NX-100
Password: guest

Other settings can be viewed with a browser or the setup program.

(4) Firmware Update

Updates firmware.

Step 1. Press the Browse button.

The Choose file dialog opens.

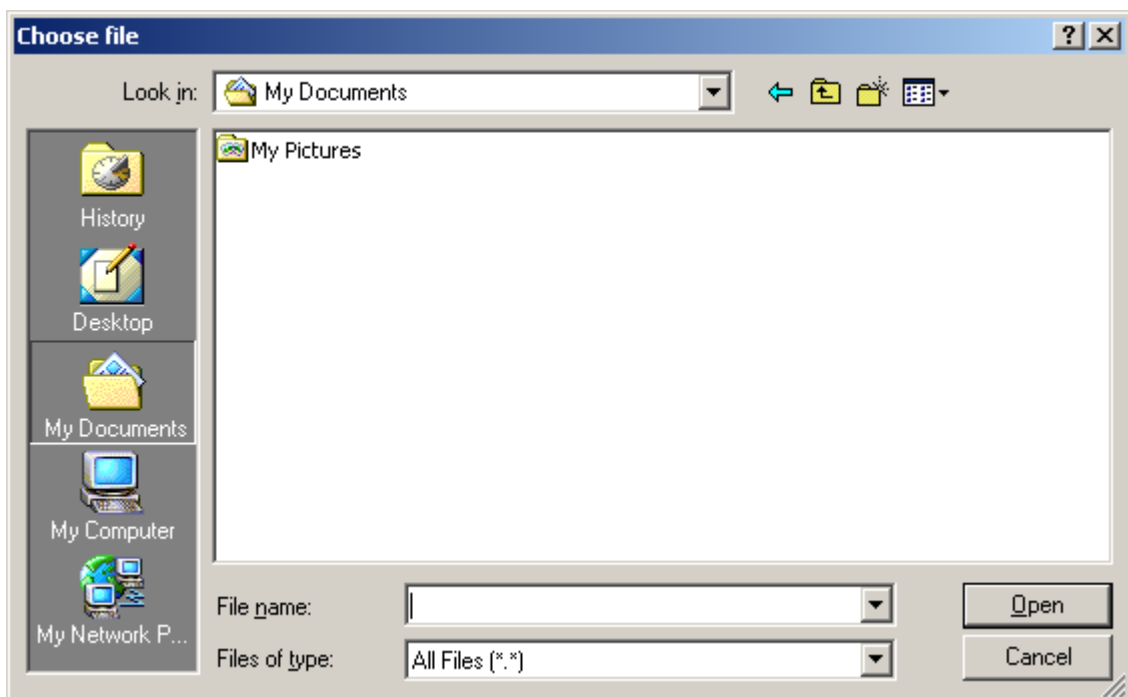

Step 2. Select the NX-100 firmware (".bin" extension), then press the Firmware Update button.

Caution

Never restart the unit or turn off the power during updates, or while the STATUS indicator on the front panel of the NX-100 is flashing.

Tips

- The latest versions of the following software and manuals are open to the public on the Toa's download site <http://www.toa-products.com/international/>: NX-100 firmware, NX-100 software (Setup program and Operation program), and Instruction manuals (Installation setup manual and Operations manual). Please download them from the above web site.
- The version of each instruction manual is in the lower right corner on the last page expressed in a year-month format. Example: "200304" represents 2003, April.

(5) Restart button

Restarts the NX-100 unit. Be sure to restart any time the setting contents are changed. The change is only enabled after restart.

Cautions

- Never restart the unit or turn off the power during updates, or while the STATUS indicator on the front panel of the NX-100 is flashing.
- Broadcasts are interrupted when the unit is restarted.

Chapter 5

OPERATION SETTINGS (NX-100 OPERATION PROGRAM)

1. NX-100 OPERATION PROGRAM SUMMARY

This operation program is used to set the control buttons used for broadcasts, and activate set NX-100 broadcast patterns*1 or operate the contact output*2.

*1 The broadcast pattern is determined by the combination of the contents of the sound source and the units targeted to receive the broadcast. One target unit can be set for unicast streaming, and up to 64 units for multicast streaming. Only one pattern can be set per button.

Note

For more information concerning broadcast pattern settings, refer to [Chapters 3](#) and [4](#).

*2 The NX-100's contact output is controlled via the network. Up to 64 units x 8 channels can be controlled per button.

2. STARTUP AND INITIAL SCREEN

Either double-click on the Operation program icon created on the desktop at the time of program installation or double-click on the application [nx100_control.jar] installed in the software folder. The following initial window (with nothing set in it) will then be displayed.

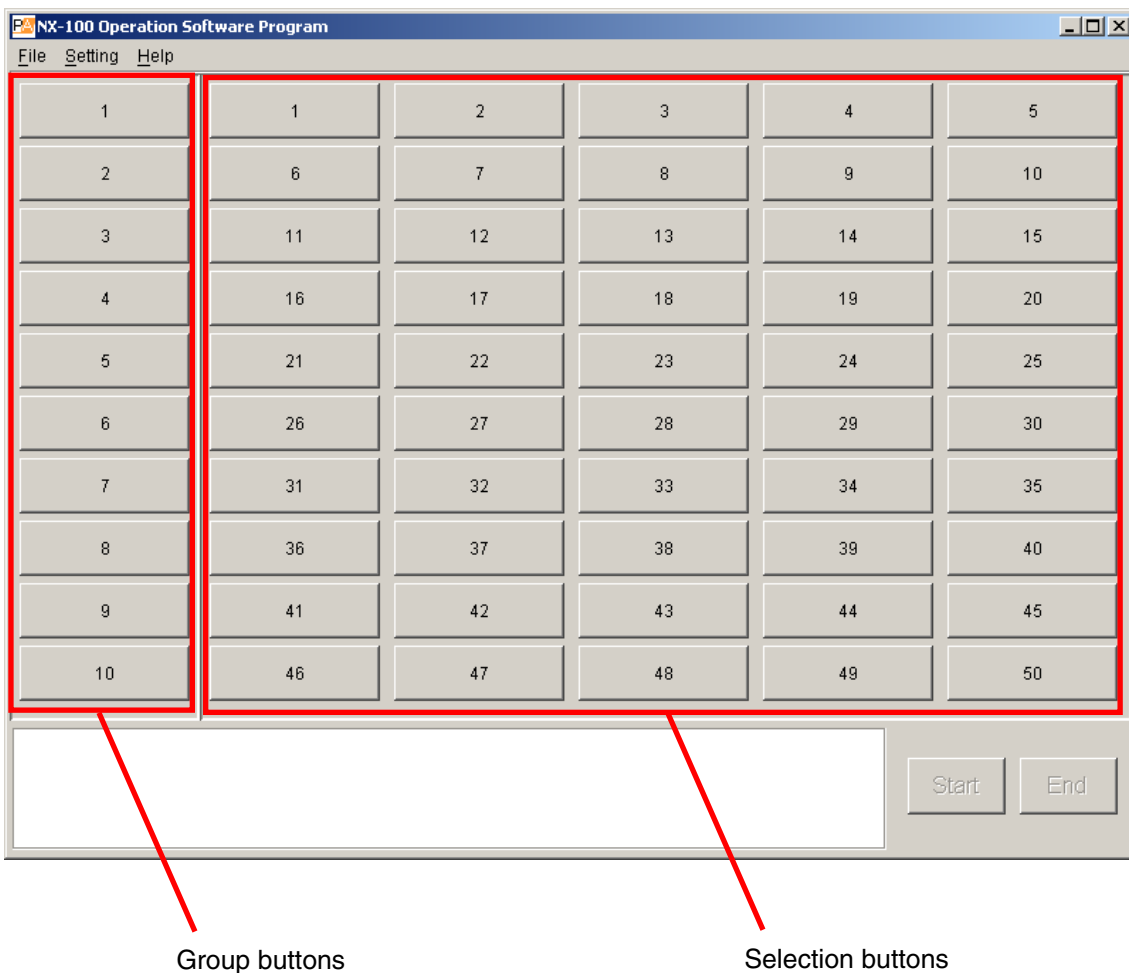

All of the 10 Group buttons and 50 Selection buttons are displayed, with each button being numbered before any button setting is performed.

3. OPERATION SCREEN DESCRIPTION

This section explains the screen layout, using the accompanying operation setting screen as an example.

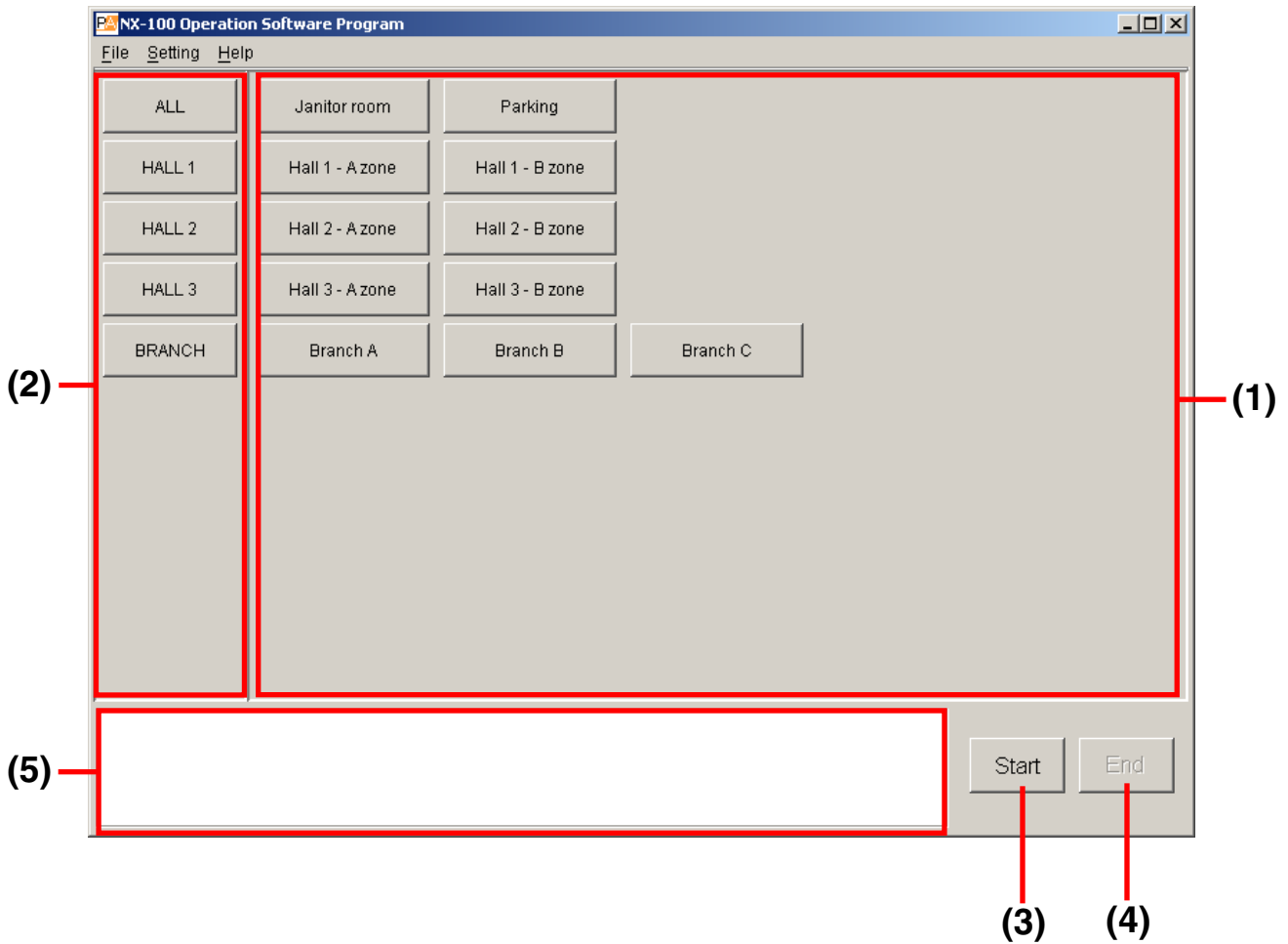

(1) Selection Button

Selects the broadcast pattern and contact output to be activated. Up to 50 buttons can be used for programming. One broadcast pattern or up to 64 units X 8 contact output channels can be set per Selection button.

(2) Group Button

Used to simultaneously select two or more Selection buttons. Up to 10 buttons can be used for programming.

(3) Start Button

Starts up the activation contents (broadcast pattern and contact output) selected with the Selection or Group buttons.

(4) End Button

Terminates activated broadcasts or contact outputs.

(5) Message Display Area

Displays responses to operations or the contents of errors.

4. MENU

4.1. File



Exit: Terminates the software program currently in use.

4.2. Settings

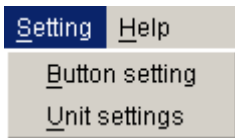

Button setting: Set the Selection button and the Group button.

Unit settings: If there is a unit that has not yet been programmed into the system using the NX-100 setup program, select this menu item to add it as the operable unit.

4.3. Help

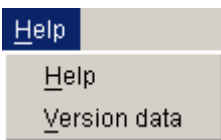

Help: Displays help contents.

Version data: Indicates the version number of the software program in use.

5. SETTING PROCEDURES USING THE OPERATION PROGRAM

Before performing the setting using the Operation program

Set the NX-100 units in the system using the NX-100 Setup program.

Broadcast settings that will be activated by the operation program must all be programmed into each connected unit as the "broadcast pattern."

The NX-100 Setup program cannot be used to set NX-100 units connected via the Internet.

If the system contains NX-100 units not set with the Setup program such as the units connected through the Internet.

If only NX-100 units set with program are used.

(1) Add the unit to the system.

NX-100 units set with the Setup program as system units are automatically recognized as operable units by the NX-100 Operation program. NX-100 units which were set without using the NX-100 Setup program, such as the units connected through the Internet, can be added to the system setting using the NX-100 Operation program.

(2) Set the Selection buttons.

Set the Selection buttons that select the broadcast patterns or contact outputs to be activated. Use the broadcast patterns which were programmed into the operable units (those units set with the NX-100 Setup program and added in Step (1) above).

Only one pattern can be programmed into each Selection button.

When simultaneously activating two or more broadcast patterns with the Group button, all of the broadcast patterns to be activated must first be programmed into the Selection buttons.

If simultaneously activating multiple broadcast patterns

(3) Set the Group buttons.

Use the Group button when wishing to simultaneously activate two or more broadcast patterns. Select and assign the desired Selection buttons to each Group button.

6. UNIT SETTING ADDITION

Set the broadcast pattern data necessary for the Selection button setting using the NX-100 Setup program (refer to [Chapter 3](#)). If a unit setting file has already been created, the data is automatically loaded. However, NX-100 units which are connected through the Internet and cannot be set with the NX-100 Setup program must be added using the Operation program. In order to activate the NX-100 broadcast pattern set using a browser (refer to [Chapter 4](#)), add the unit setting using the following procedure:

Step 1. Turn on the power to the NX-100 unit for which the unit setting is to be added to make connections possible.

Step 2. Start up the Operation program and select Setting → Unit settings.

The User Authentication screen is then displayed.



The image shows a 'User Authentication' dialog box with a title bar containing a small icon and the text 'User Authentication'. The main text inside the box says 'Enter system name and password.' Below this, there are two input fields: 'System name:' with the text 'NX-100' entered, and 'Password:' with '*****' entered. At the bottom of the dialog are two buttons: 'OK' and 'Cancel'.

Step 3. Enter the system name and the password (the same password used in the setup program), then press the OK button.

Notes

- Both the system name and the password are case-sensitive.
- The default system name is preset to "NX-100" and the password to "guest" when the unit is shipped from the factory. To change, refer to [p. 3-32](#) or [p. 4-28](#).

The Unit Settings window is displayed if the system name and the password are correctly entered.

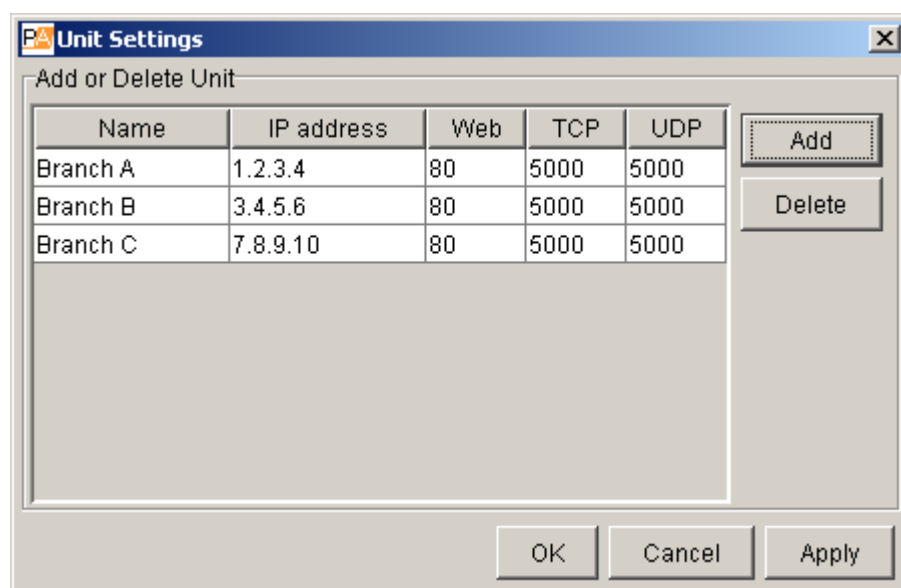

The image shows a 'Unit Settings' dialog box with a title bar containing a small icon and the text 'Unit Settings'. The main text inside the box says 'Add or Delete Unit'. Below this is a table with five columns: 'Name', 'IP address', 'Web', 'TCP', and 'UDP'. There are three rows of data: 'Branch A', 'Branch B', and 'Branch C'. To the right of the table are two buttons: 'Add' and 'Delete'. At the bottom of the dialog are three buttons: 'OK', 'Cancel', and 'Apply'.

Name	IP address	Web	TCP	UDP
Branch A	1.2.3.4	80	5000	5000
Branch B	3.4.5.6	80	5000	5000
Branch C	7.8.9.10	80	5000	5000

Note

In the initial startup mode, nothing is displayed in the Name, IP Address, Web, TCP and UDP columns.

Step 4. Press the Add button.

A Unit Addition dialog is displayed.

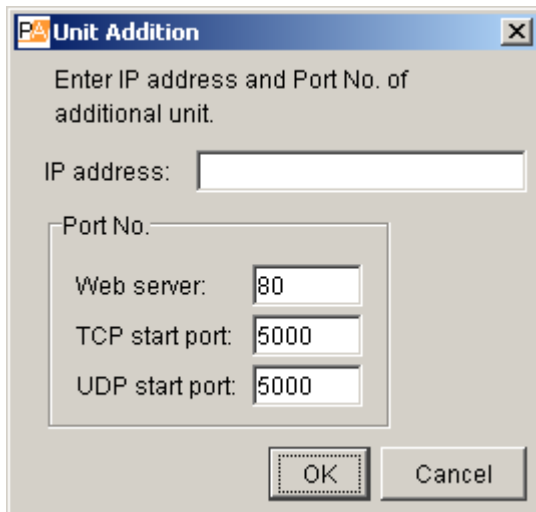

The image shows a dialog box titled "Unit Addition" with a close button (X) in the top right corner. The dialog contains the following fields and controls:

- Text: "Enter IP address and Port No. of additional unit."
- Text: "IP address:" followed by an empty text input field.
- Text: "Port No." followed by a group box containing three sub-fields:
 - Text: "Web server:" followed by an input field containing the value "80".
 - Text: "TCP start port:" followed by an input field containing the value "5000".
 - Text: "UDP start port:" followed by an input field containing the value "5000".
- Buttons: "OK" and "Cancel" buttons at the bottom right.

Step 5. Enter the IP address and port number (Web server, TCP start port number, and UDP start port number), then press the OK button.

The entered data is displayed on the Unit Settings window.

Step 6. To save the changed contents without quitting the Unit Settings screen, press the Apply button.

The NX-100 with the entered IP address is connected, and its setting data downloaded.

The name is displayed on the Unit Settings screen when downloaded. The name cannot be edited.

The downloaded setting contents are saved to the data folder in the software program installation folder.

Step 7. Press the OK button after all necessary NX-100 units have been added.

The NX-100 units with the entered IP address are connected, and their setting data downloaded.

After the downloading of all units is completed, the Unit Settings screen is closed.

The downloaded setting contents are saved to the data folder in the software program installation folder.

Tips

- When a unit cannot be connected, the dialog [Connection failure to "XX". Delete?] is displayed. Pressing the OK button deletes the faulty NX-100 from the Unit Settings screen list, and the data is saved. Pressing the Cancel button cancels the setting change. Setting can be attempted again after confirming the setting contents.
- To delete an NX-100 unit from the Unit Settings screen list, select the desired NX-100 unit and press the Delete button.

7. SETTING THE SELECTION BUTTON CONTENTS

Program the broadcast pattern and the contact output activation setting into the Selection button.

Step 1. Start the Operation program and select [Setting] → [Button setting].

The User Authentication screen is displayed.

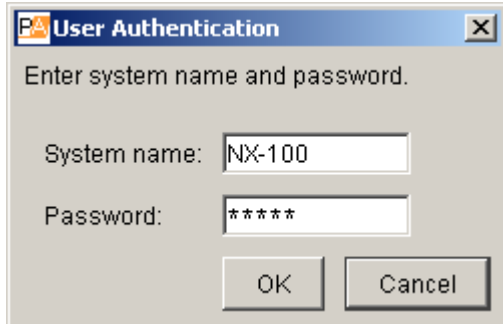

Step 2. Enter the system name and the password (the same system name and password entered in the setup program), then press the OK button.

Notes

- Both the system name and the password are case-sensitive.
- The default system name is preset to "NX-100" and the password to "guest" when the unit is shipped from the factory. To change, refer to [p. 3-32](#) or [p. 4-28](#).

The Button Setting screen is displayed if the system name and the password have been correctly entered.

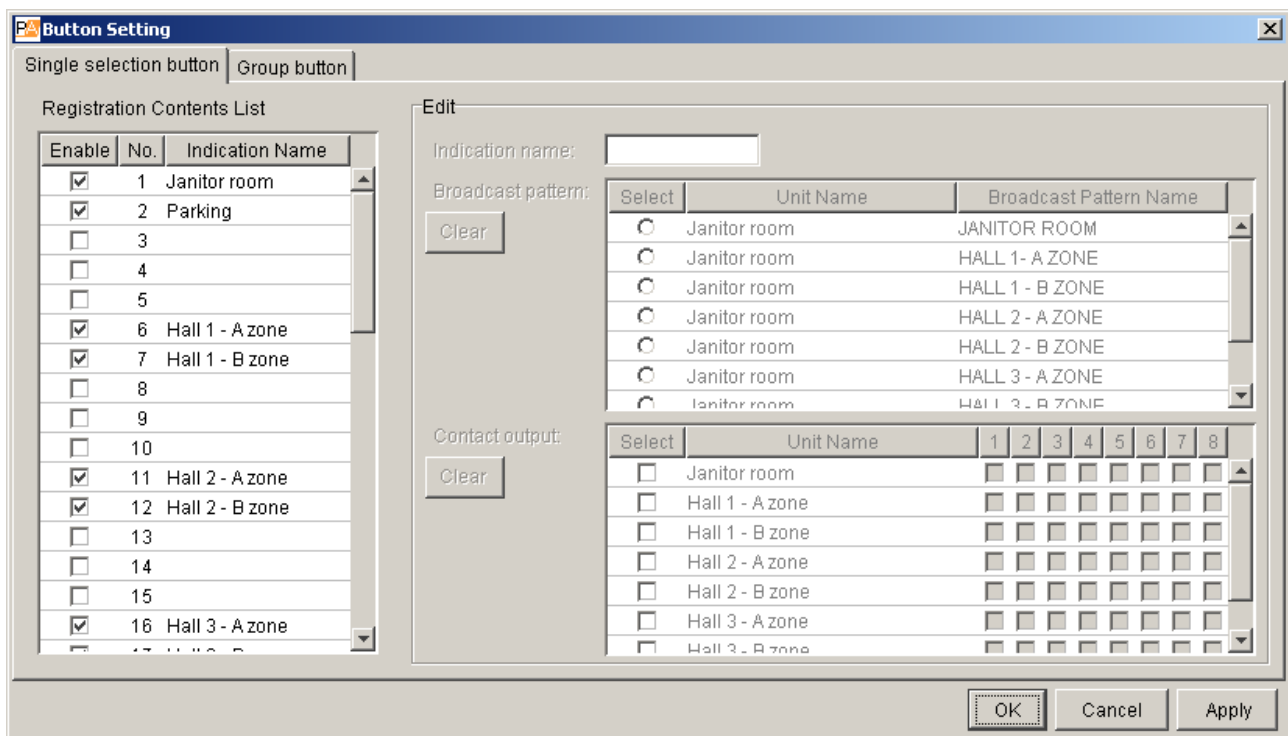

Step 3. Click on the Single selection button tab.

The following initial Single selection button setting window is displayed.

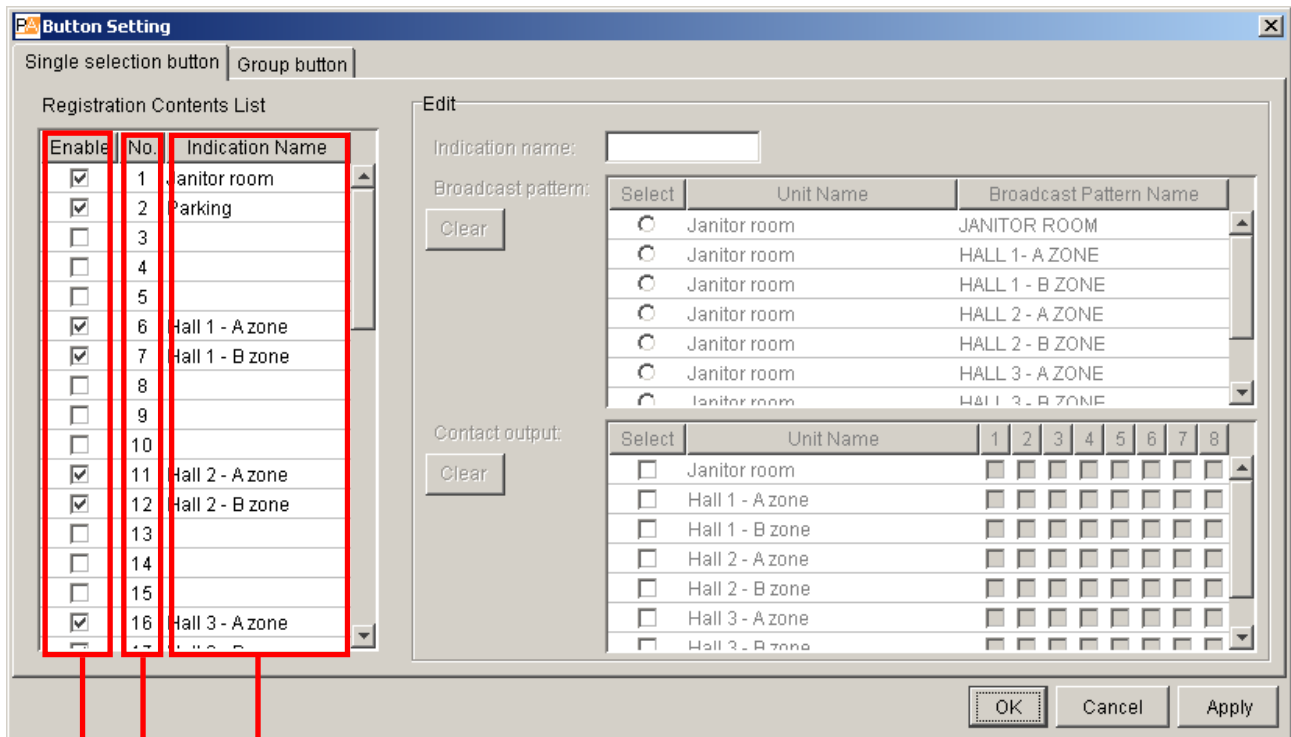

(1) (2) (3)

[Registration Contents List]

(1) Enable

Displays or hides the Selection buttons.

(2) No.

Selection button numbers. These numbers cannot be changed. The buttons are arranged in the order of the button number (see figure at right) on the operation screen.

(3) Indication Name

The name of the Selection button to be displayed on the operation screen.

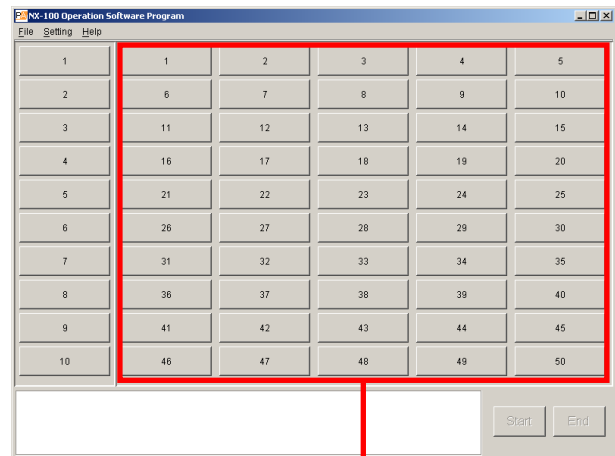

Selection button arrangement

Step 4. Click off the checkbox ticks in the Registration Contents List for Selection buttons not to be used on the operation screen.

Buttons not marked with a tick are not displayed on the operation screen.

Step 5. Click on the Selection buttons (the No. or Indication Name area) to be edited in the Registration Contents List.

The contents are displayed in the Edit area.

Step 6. Enter the Indication name in the Edit area.

Tip

There is no limit to the number of characters that can be entered, however the maximum number of characters that can be displayed on the operation screen buttons for the screen size at startup is 16. Because the number of displayed characters increases as the display screen increases in size, set the number of characters to correspond to the screen size to be used.

Step 7. Check the broadcast pattern to be activated in the Broadcast pattern list.

Tips

- The Broadcast pattern list displays all patterns that have been programmed into all NX-100 units in the system, including the NX-100 units added in the unit setting procedure (p. 5-6).
- Only one broadcast pattern at a time can be selected.
- To clear the setting contents of the selected NX-100 broadcast pattern, press the leftmost Clear button in the Edit area.

Step 8. Check the contact output to be activated in the Contact output list.

The contact channel number to be output can be selected.

(Setting screen example)

Broadcast pattern list

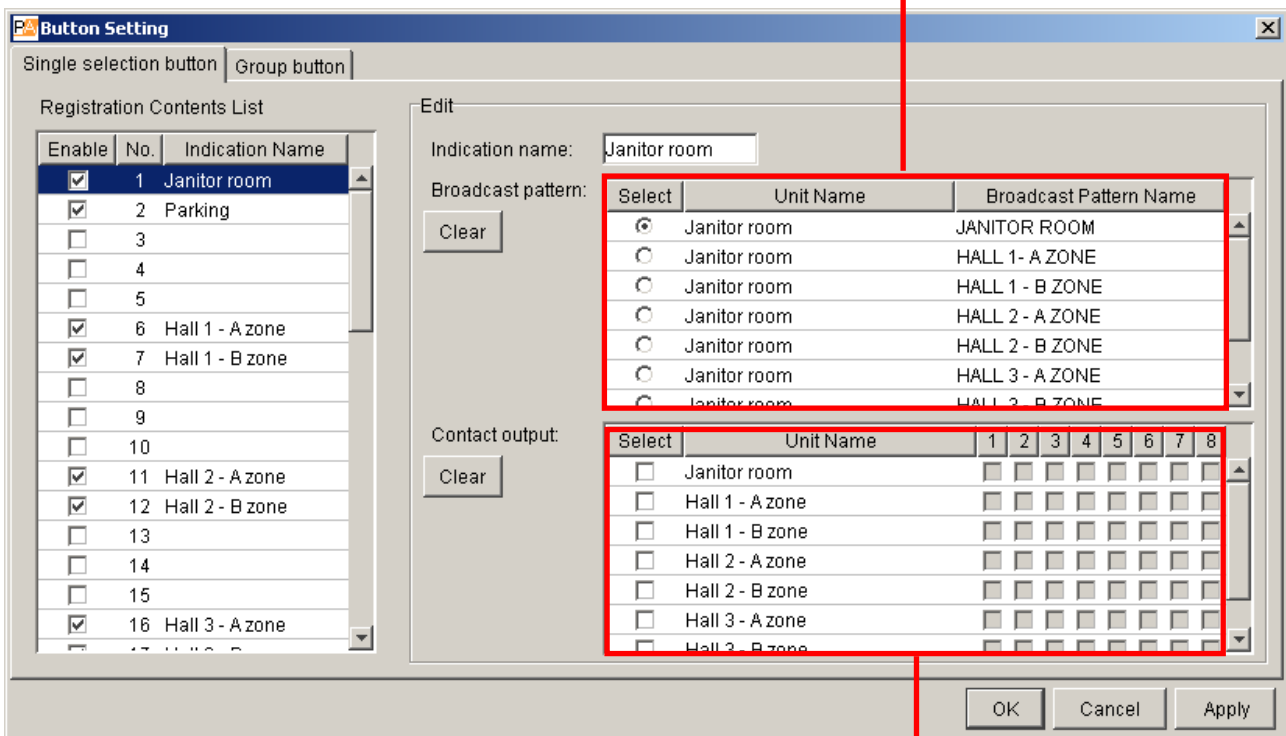

Contact output list

Step 9. Check the contact channel number to be used.

Tip

To clear the setting contents of all NX-100 contact outputs, press the leftmost Clear button in the Edit area.

Step 10. To save the setting contents without quitting the Single selection button setting screen, press the Apply button.

The setting contents are saved to the data folder located in the installation folder (default path: C:\Program Files\TOA\NX-100) of the software program.

Step 11. Press the OK button after completing all editing tasks.

The setting contents are saved to the data folder located in the installation folder (default path: C:\Program Files\TOA\NX-100) of the software program, and the Single selection button setting screen is closed.

8. SETTING THE GROUP BUTTON CONTENTS

The Group button is used to simultaneously select two or more Selection buttons. Program the desired Selection buttons into the Group button.

Step 1. Click on the Group button tab on the Button Setting screen (p. 5-8).

The following initial Group button setting screen is displayed.

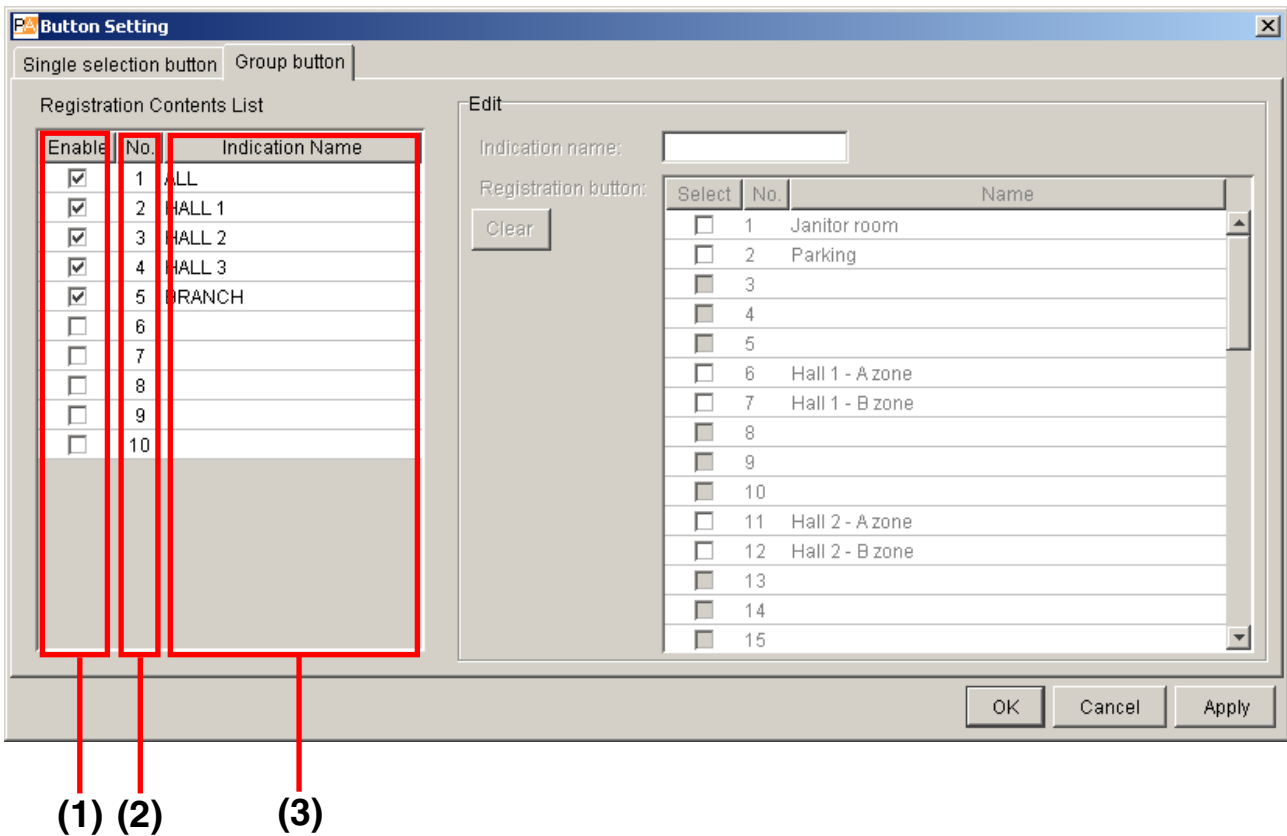

[Registration Contents List]

(1) Enable

Displays or hides the Group buttons.

(2) No.

Group button numbers. These numbers cannot be changed. The buttons are arranged in the order of the button number (see figure at right) on the operation screen.

(3) Indication Name

The name of the Group button to be displayed on the operation screen.

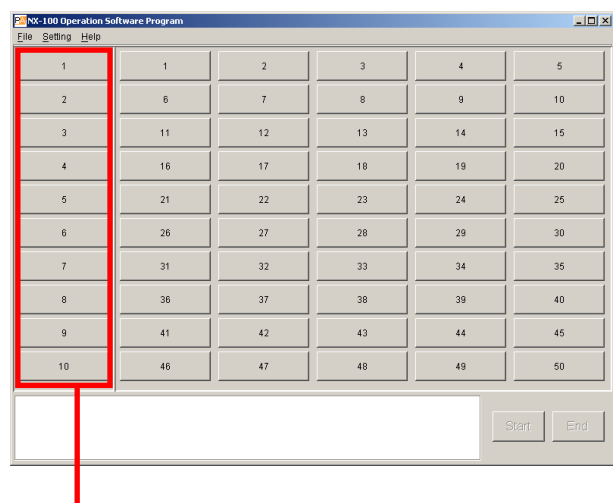

Group button arrangement

Step 2. Click off the checkbox ticks in the Registration Contents List for Group buttons not to be used on the operation screen.

Buttons not marked with a tick are not displayed on the operation screen.

Step 3. Click on the Group buttons (the No. or Indication Name area) to be edited in the Registration Contents List.

The contents are displayed in the Edit area.

Step 4. Enter the Indication name in the Edit area.

Tip

There is no limit to the number of characters that can be entered, however the maximum number of characters that can be displayed on the operation screen buttons for the screen size at startup is 16. Because the number of displayed characters increases as the display screen increases in size, set the number of characters to correspond to the screen size to be used.

Step 5. Check the Selection buttons to be assigned in the Registration button list.

Tips

- The Registration button list displays the numbers and names of the Selection buttons. Only the Selection buttons programmed on the Single selection button setting screen can be checked.
- If an invalid combination is set for broadcast, an error message will be displayed when the Start button is pressed on the operation screen.
- To clear the setting contents of the selected Group button, press the Clear button.

Step 6. To save the setting contents without quitting the Group button setting window, press the Apply button.

The setting contents are saved to the data folder located in the installation folder (default path: C:\Program_Files\TOA\NX-100) of the software program.

Step 7. Press the OK button after completing all editing tasks.

The setting contents are saved to the data folder located in the installation folder (default path: C:\Program Files\TOA\NX-100) of the software program, and the Single selection button setting screen is closed.

(Setting screen example)

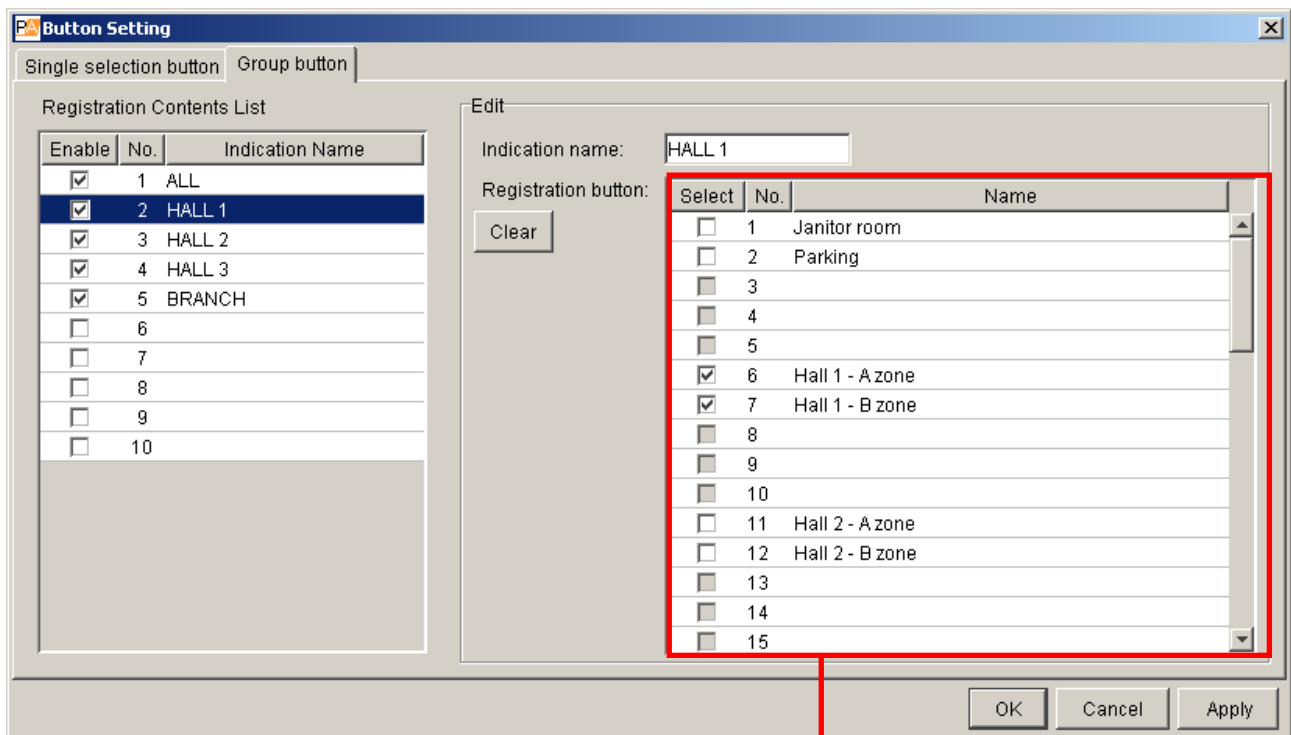

Registration button list

9. ERROR MESSAGES

If any of the following messages is displayed in the message display area, the NX-100 may be malfunctioning or have failed.

Message	Points to Check
<ul style="list-style-type: none"> • "OO" connection failure. • Connection failure to all designated units. • "OO" connection failure - Incomplete broadcast. • No broadcast. - Connection failure to all units. • Interrupted broadcast to "OO". • Interrupted broadcast from "OO". <p>Note: The above messages are displayed in red.</p>	<p>The NX-100 unit may have failed. Check to see if the power supply is correctly connected, that there are no irregularities in the network, and whether or not the NX-100's front panel-mounted Error indicator is lit.</p>
<ul style="list-style-type: none"> • "OO" connection failure. - Invalid system name. • No start. - Invalid broadcast setting contents. • "OO" contact output "XX" set to OFF. 	<p>Settings may be incorrect. Check both the Setup and Operation programs for correct setting.</p>
<ul style="list-style-type: none"> • "OO" connection failure. - Maximum number of connectable PCs exceeded. • No start. - Designated unit busy. • "OO" contact output "XX" already ON. • "OO" contact output "XX" turned OFF by other contact or PC. • "OO" contact output "XX" already OFF. 	<p>The unit may be simultaneously activated from multiple units. Restart up the unit after broadcasts from other units have finished.</p>

Note

In the above messages, "OO" indicates a unit's name and IP address, and "XX" indicates the channel number.

Chapter 6

APPENDIX

1. EXPLANATION

1.1. IP Network and Address

The IP networks the NX-100 can use include Local Area Networks (LAN) used in small-scale areas, such as within or on the premises of a company, and the Internet, which covers a wide area over remote distances.

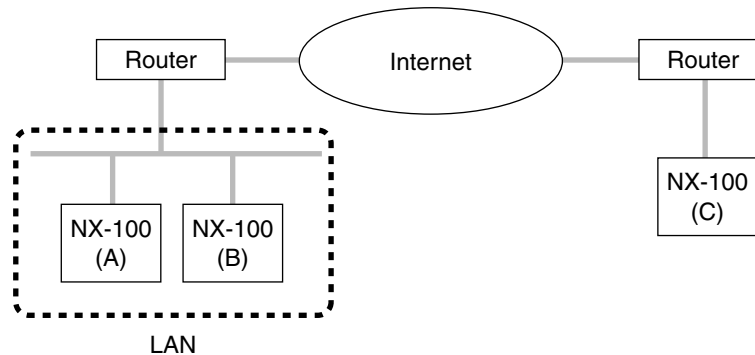

LANs differ from the Internet in the IP address to be used.

Local IP address (private IP address): This address is used and can be freely set within the LAN.

Global IP address: This is the only address that is used to access the Internet.
To use the NX-100 unit through the Internet, a fixed global IP address must be acquired and assigned to the NX-100 or the router if it is used.

When a connection is made from Unit B to Unit A in the figure, the local address can be used. However, when a connection is made from Unit C to Unit A, the global IP address must be used.

The fixed global IP address must be assigned to the units connected via the Internet.

When selecting an NX-100 which is connected through the Internet as the "target connection unit" for a broadcast pattern, contact or serial bridge in NX-100 unit setting, the fixed global IP address must be designated.

Consult with network management personnel or the ISP (Internet service provider) concerning the acquisition of a fixed global IP address.

1.2. Network Address Translation (NAT) and Setup Software Programs

Because the Internet cannot be accessed using the local IP address, the local IP address must be converted into the global IP address by means of Network Address Translation (NAT).

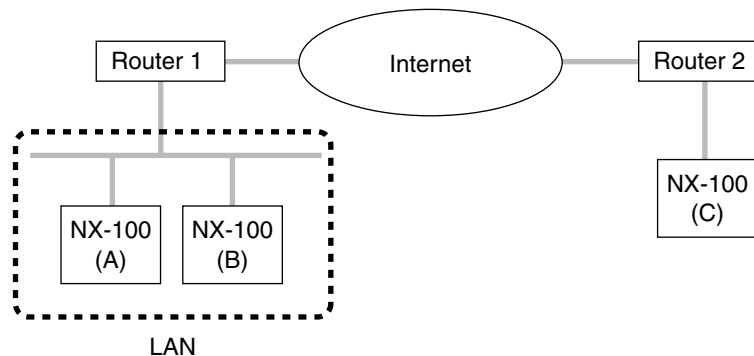

Connections can be made from Unit C to Unit A using the global IP address. The global IP address used for the connection is converted into the local address for Unit A by Router 1.

Note that the NX-100 Setup program is not designed to enable the NAT function. Use a browser to select units connected by way of the NAT as the target connection unit for the broadcast pattern, contact or serial bridge in the NX-100 unit settings.

1.3. IP Broadcast and Unit Scan

The IP broadcast communication method is used to scan the units connected to the network. Units can only be scanned within the effective range of the IP broadcast.

The address to be used is 255.255.255.255.

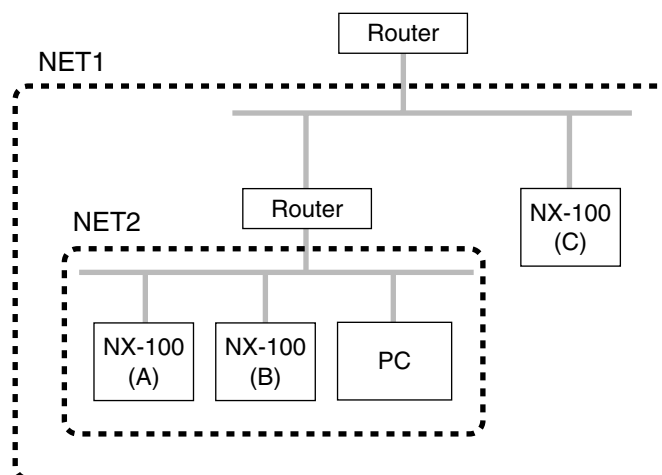

IP broadcast does not reach beyond the router covering range even in the LAN.

In the above figure, NET1 represents the LAN and NET2 represents the effective range for IP broadcast. For example, if the PC is used to scan the units in the figure, Unit C cannot be scanned even though it is located within the same LAN.

Note

Follow the instructions of the network management personnel for the effective range of the IP broadcast.

1.4. Multicast and Simultaneous Multiple Broadcasts

The multicast communication method can be utilized to make simultaneous broadcasts to two or more units. The advantage of multicast operation is the possibility of decreasing traffic. Networks that use multicast communication need to be supported by multicast addresses and Internet Group Management Protocol (IGMP). The effective multicast address range is from 225.0.0.0 to 238.255.255.255.

Note

Follow the instructions of the network management personnel for the effective range of the broadcast.

1.5. Packet Loss Recovery

The NX-100 converts audio data into IP packets to carry out communications. According to the condition of the network to be used, packets may be lost, deteriorating sound quality. The NX-100 offers the following 3 different selection modes for recovering such lost packets.

- Standard:** Corrects for lost packets with a silent gap. This method helps reduce delay times and bandwidth, and is appropriate for applications that emphasize real-time operability. However, it is not well-suited to networks in which many packet losses may occur, because the good sound quality cannot be maintained.
- Error Correction:** Recovers lost packets with redundant data. Since only short-time losses can be corrected, this method is not appropriate for networks in which many packet losses may occur. It is, however, appropriate for applications that require high sound quality, such as LAN, which have lower chances of packet loss.
- Resend:** Corrects by automatically resending lost packets. All packet losses that occur within the preset delay time can be corrected. High sound quality can be maintained even on such networks as the Internet, which may generate many packet losses. This method, however, is not well-suited to applications that emphasize real-time operability, because of longer delay times.

	Packet loss recovery ability	Real-time operability	Band occupation
Standard	3	1	Small
Error correction	2	2	Moderate
Resend	1	3	Large

Note: Numbers represent level of advantage in the order of 1, 2, 3.

1.6. Contact OFF Delay Time

Depending on the packet loss recovery setting, delay times may be generated in broadcasts. Long delay times do not take place in the contact bridge function. Therefore, if the contact is set so that it becomes OFF when broadcasts are terminated, the contact may be turned OFF before broadcast completion. To leave the contact ON until broadcast completion, the contact OFF delay time of the NX-100 that provides contact output needs to be set to be longer than the broadcast delay time in the contact setting. (The broadcast delay time is displayed on the Broadcast Spec setting screen.)

1.7. Sampling Frequency Correction

Synchronizes all NX-100 operation clocks in the system.

Unless the operation clocks are all synchronized, sound losses can occur in broadcasts that last more than 2 minutes. For example, to realize sampling frequency (fs) correction between units connected to Networks A and B, perform fs correction data transmission setting for any one of the NX-100 units connected to Network A. Set the target transmission unit of the correction data to the Network B router IP address. Set the sampling frequency reception for any one of the NX-100 units connected to Network B. Add the address translation of the unit set to receive the correction data to the Network B router.

Note, however, that this setting is not needed when limited to use within the LAN*, because the sampling frequency is automatically corrected.

* Broadcast effective range

2. TROUBLESHOOTING

Symptom	Remedy
Cannot start up. No LEDs light.	Confirm that power is correctly connected.
	Turn power on again.
LNK/ACT LED does not light.	Confirm that LAN cable is correctly connected.
	Confirm that the NX-100 is connected to the correct switching hub's port and that the proper type of cable is used for the connection. → Refer to p. 2-3, Network Connections , for connections to other networks.
Setup/Operation programs do not start up.	Confirm that Java Runtime Environment is installed in PC using the Setup/Operation programs. → Refer to p. 2-9, Installing Java Runtime Environment , for correct installation.
	Check version number of installed Java Runtime Environment. Unit may malfunction if version numbers differ. → Refer to p. 2-9, Installing Java Runtime Environment , for confirmation of the version number.
Setup/Operation programs cannot recognize NX-100 unit.	Confirm that PC using Setup/Operation programs is correctly connected to network.
	Confirm that unit's IP address, subnet mask, and default gateway are correctly set. → Refer to p. 3-9, Unit Scanning Tool , or p. 4.4, Network Setting , for network setting procedures.
	When connected to other networks via router, confirm with network management personnel if the router is properly set.
	If Java Runtime Environment is set to operate via a proxy server, indications may not be properly displayed. Cancel the use of proxy. (Perform this operation from the Control Panel.)
Browser setting screen is not properly displayed.	Check PC using Setup/Operation programs by way of browser for correct connection. Also, confirm that browser is correctly set.
	Setting screen uses Java Script. Confirm that browser is Java Script-compatible and that the function is set to Enable.
	Screen may not be properly displayed if browser is set to use a proxy server. Do not use proxy server.
Cannot carry out communications using RS-232C interface.	Check to see if correct type of cable is used.
	Confirm that serial communication settings of both original and connected units are correct. → Refer to p. 3-28, Serial Bridge Setting , for serial communication setting.
Control inputs and outputs do not operate.	Confirm that connections are correctly made to equipment that meets unit's control I/O specification requirements.

Symptom	Remedy
Outputs no audio signal or distorted signal.	Confirm that sound source equipment, amplifier, and speaker are correctly connected.
	Confirm that audio input volume control is properly adjusted.
	Confirm that the rear-mounted input level selection switch is set to appropriate position.
	Check audio activation control input for correct setting. → Refer to p. 3-24, Contact Setting , or p. 4-13, Contact Setting , for control input activation.
	Check to see if audio-related settings, such as sampling frequency and compression, are correct. → Refer to p. 3-19, Broadcast Spec Setting , or p. 4-6, Broadcast Spec Setting , for audio-related settings.
Audio output is affected by noise or lost.	When hum noise is heard, unit's FG terminal may not be correctly connected. → Check to see if it is correctly connected.
	When short noises are heard or when audio output is lost, network may be congested. Check log contents. If congestion is found, consult with network management personnel. → Refer to p. 4-24, Stream Logs , to confirm log contents.
Audio outputs are mixed.	When broadcasts are heard mixed in multicast streaming, the same multicast address may have been set for some broadcasts in Broadcast Spec setting. → Avoid duplication of multicast address when performing settings for system units.
Other malfunctions	When other malfunctions occur, Error indicator may light. → Since serious failure may have occurred when Error indicator lights, check log. Refer to p. 4-21, Operation Log , to confirm log contents.
Error message is displayed during operation using Operation program.	Incorrect settings or NX-100 failure may be cause. → Refer to p. 5-14, Error Messages , for details.
Forgot password.	Contact TOA dealer.

3. SPECIFICATIONS

Power Source	24 V DC (removable terminal block) or AC adapter AD-246 (optional) or the equivalent
Current Consumption	200 mA (DC operation)
Audio Input	1 channel (transformer-isolated), -58 dB* to 0 dB*, balanced (MIC/LINE changeable, volume adjustable with volume control), 2 kΩ, removable terminal block
Audio Output	1 channel (transformer-isolated), balanced, 600 Ω, removable terminal block
Frequency Response	50 – 14,000 Hz (when sampling frequency is 32 kHz)
Distortion	Under 0.3% (1 kHz, when sampling frequency is 32 kHz)
Control Input	8 channels, no-voltage make contact input, open voltage: 12 V DC, short-circuit current: 10 mA, removable terminal block
Control Output	8 channels, open collector output (polarized), withstand voltage: 30 V DC, control current: 50 mA max., removable terminal block
Network I/F	10BASE-T/100BASE-TX, Auto-Negotiation
Network Protocol	TCP/IP, UDP, HTTP, RTP
Audio Packet Transmission System	Unicast (Up to 4 simultaneous transmissions), Multicast (Up to 64 simultaneous transmissions)
Operating Temperature	0°C to +50°C (0°C to +40°C when AC adapter is in use)
Operating Humidity	Under 90% RH (no dew condensation should be produced)
Finish	Steel plate, black (30% glossy)
Dimensions	210 (w) x 46 (h) x 188 (d) mm
Weight	1.2 kg

* 0 dB = 1 V

Note: The design and specifications are subject to change without notice for improvement.

• Optional products

Rack mounting bracket: MB-15B-BK (for rack-mounting one NX-100 unit)
MB-15B-J (for rack-mounting two NX-100 units)

AC adapter: AD-246

Note: When you need the AC adapter, be sure to consult your TOA dealer.